

BK MIKRO 50/100-LIN.B

*Tool monitoring system for linear scanning
Scanners with maximum stroke of 50 mm or 100 mm*

*Operating Instructions
Issue 1.01*

Released: Jan, 2001



553 Industrial Dr. Hartland, WI 53029 262-367-8665 fax 262-367-0208
web-site www.techna-tool.com email techtool@techna-tool.com

General Notice

Safety guidelines

These operating instructions contain notices, which you should observe to ensure your own personal safety, as well as to protect the product and connected equipment. These notices are highlighted in the manual by a warning triangle and are marked as follows according to the level of danger:



Immediate danger

to life and limb of personnel and others.

Non-compliance may cause death or serious (crippling) injury.



Hazardous situation

to life and limb of personnel and others.

Non-compliance may cause death or serious injury.



Potentially hazardous situation

Non-compliance may cause slight injury;
possible damage to property.



Notes on correct handling

Non-compliance may cause damage to the product
and/or damage to parts/items in the vicinity.



Environmental protection

Non-compliance may have an impact on the environment.

Intended use



BK MIKRO is a control system suitable for tool as well as for object and free space monitoring applications. It may only be used for the applications described in the technical documents, and only in connection with devices or components from other manufacturers which have been approved or recommended by us.

This product can only function correctly and safely if it is transported, stored, set up, and installed correctly, and operated and maintained as recommended.

Qualification of personnel

Only qualified personnel may carry out the following activities on the control system: installation, commissioning, operation, and maintenance.

Qualified persons in accordance with the safety guidelines are defined as persons who are authorized to commission, to ground, and to tag circuits, equipment, and systems in accordance with established safety practices and standards.

Disclaimer of liability

We have checked the contents of this document for agreement with the hardware and software described. Since deviations cannot be precluded entirely, we cannot guarantee full agreement. However, the data in this manual are reviewed regularly and any necessary corrections included in subsequent editions. Suggestions for improvement are welcomed.

EEC directive EMC 89/336/EEC

The following applies to control system BK MIKRO:



Products which carry the CE symbol meet the requirements of the EEC directive 89/336/EEC on electromagnetic compatibility.

The EEC declarations of conformity and the related documentation will be maintained at the following address for inspection by the responsible officials in accordance with article 10(1) of the above stated EEC directive:

Leukhardt Systemelektronik GmbH
Rudolf-Diesel-Straße 17
D-78532 Tuttlingen

Areas of use

Control systems of the BK MIKRO series meet the applicable, harmonized, European standards for the respective area of applications.

Fitting conditions

The fitting conditions and safety notes in the operating instructions must be adhered to when commissioning and operating the devices.

Copyright

These operating instructions are intended for the operator and the operator's personnel only. This document and its contents may not be disclosed to third parties, either in full or in part, by reproduction, transmission or any other means without express written authority.

Non-compliance may lead to prosecution under criminal law.

Contents

1	Characteristics	3
2	System Components	4
2.1	Control unit	4
2.1.1	Technical data	6
	Mechanical dimensions	7
2.1.2	Connection terminals	7
	Power supply.....	7
	Control inputs.....	8
	Selection inputs	8
	Relay outputs.....	9
2.1.3	Light-emitting diodes.....	9
2.1.4	Rotary switches	10
2.1.5	Toggle switches	10
	"Scanning intensity" switch.....	11
	"Output relay" switch.....	11
	"Scanner" switch	11
	"Tolerance range" switch(es).....	11
	"O.K. indication" switch.....	11
2.1.6	Notes on technical safety.....	12
2.2	Scanner.....	13
2.2.1	Technical data	13
	Mechanical dimensions	14
	TK50-LIN.B = "50 mm max. stroke"	14
	TK100-LIN.B = "100 mm max. stroke"	14
2.2.2	Accessories.....	15
2.2.3	Scanning Wand.....	15
	Stop position.....	15
	Initial position.....	15
	Scanning range.....	15
	Exchange the scanning tip	15
2.3	Connection cable	16
3	Mode of Operation	17
3.1	Scanning process.....	17
3.2	Reference procedure when system is switched on	17
3.3	Output of results	18
3.4	Return travel monitoring	18
4	Monitoring Functions	19
4.1	Teach mode = Monitoring with learn function.....	19
4.1.1	"Teach-in", the learn cycle.....	19
4.1.2	"Start", the real scanning process	20
4.1.3	Multi Learn.....	20
4.2	Switch mode = Monitoring with setting the scanning range.....	21
4.2.1	Control operation "Object monitoring".....	21
4.2.2	Control operation "Free space monitoring"	21
4.2.3	Setting the position.....	22
4.2.4	Example for range settings.....	22
5	Cycle Times	23
	Scanning times	23

6	Status Indication.....	24
6.1	Yellow LED.....	24
6.2	Red LED / Green LED.....	24
6.3	Error messages – Flashing red and green LED.....	24
7	Installation Notes.....	25
7.1	Control voltage connection	25
7.2	Mounting brackets.....	26
7.3	Interference prevention	28
Appendix A		
Techna-Tool & Manufacturing Part Numbers.....		28

Table of Figures

Fig. 2-1:	Control unit – Front view with plug-in connections	4
Fig. 2-2:	Control unit – "Multi" and "Single"	5
Fig. 2-3:	Control unit – Dimensions	7
Fig. 2-4:	Control unit – Light-emitting diodes	9
Fig. 2-5:	Control unit – Rotary switches.....	10
Fig. 2-6:	Control unit – Toggle switches	10
Fig. 2-7:	Range of tolerance.....	11
Fig. 2-8:	Scanner TK50-LIN.B.....	14
Fig. 2-9:	Scanner TK100-LIN.B.....	14
Fig. 2-10:	Scanners – Accessories	15
Fig. 2-11:	Stop position of the wand	15
Fig. 2-12:	Connection cable – Pin configuration	16
Fig. 4-1:	"Teach-in", the learn cycle.....	19
Fig. 4-2:	"Start" cycle using "Teach mode"	20
Fig. 4-3:	"Start" cycle using "Switch mode"	21
Fig. 4-4:	Range setting using rotary switches	22
Fig. 7-1:	Control voltage connection	25
Fig. 7-2:	Mounting bracket [ø 32 mm]	26
Fig. 7-3:	Mounting bracket [ø 20 mm]	27

© Copyright Techna-Tool Inc..

Subject to change without notice.

1 **Characteristics**

BK MIKRO LIN.B is a tool monitoring system customized for longitudinal scanning applications.

The complete BK MIKRO LIN.B system comprises

- *a control unit,*
- *a sensor (scanner),*
- *a connection cable.*

BK MIKRO LIN.B is based on existing design concepts for tool, object and free space monitoring. These system monitors geometries, which require longitudinal scanning, especially in cases where rotary scanning is inappropriate or impossible, for example cavities, bore holes, limited space arrangements or critical coolant pressure.

The two control units "Multi" and "Single" have different features of monitoring:

- *Tool monitoring*
Monitoring of the scanning position whose precise location has been previously entered by "Teach-in", e.g. to carry out a tool check before each working cycle (tool monitoring), especially for "Multi": 8 scanning positions can be coded.
- *Object monitoring, free space monitoring*
Monitoring a scanning range freely selectable via two adjusting switches, e.g. to check cavities with varying depth (object monitoring), or to check bore holes (free space monitoring), only for "Multi".

Two types of scanners are available for each control unit.

TK50-LIN.B : Scanner with maximum stroke of 50 mm.

TK100-LIN.B : Scanner with maximum stroke of 100 mm.

Principle of operation

The wand of the scanner scans tools, objects or critical process spaces free of potential, in line with machine cycles.

A control unit equipped with a micro-computer triggers the movement of the wand upon an external signal and passes the scanning result on to the machine control via relay contacts.

The galvanically isolated inputs and outputs guarantee a high degree of operational safety and protection against interferences.

Further features

- *Variants for the tip of the wand (also project-specific)*
- *Two steps for scanning intensity*
- *Output relay contacts selectable as N.C. or N.O.*
- *Various ranges of tolerance for "O.K." message*
- *Indication of the scanning result by two LEDs for "O.K." and "K.O." at the control unit*
- *Detection of cable breaks*

2 System Components

2.1 Control unit

The control unit is available in three models preconfigured for different supply voltages. The relevant version will be marked on the rating plate: 24 VDC, 120 VAC, 230 VAC.

On its front panel, the control unit is fitted with plug-in screw terminals to connect all machine inputs and outputs, supply voltage, and the scanner.

- The screw terminals have been arranged on two plug-in terminal blocks. These blocks are keyed so that they cannot be accidentally plugged into the wrong socket.
- When in operation, plastic caps cover the screws in the front. Wires to be connected are routed from the top or bottom of the unit.

The scanner will be connected via a 6-wire cable to the scanner socket of the control unit.

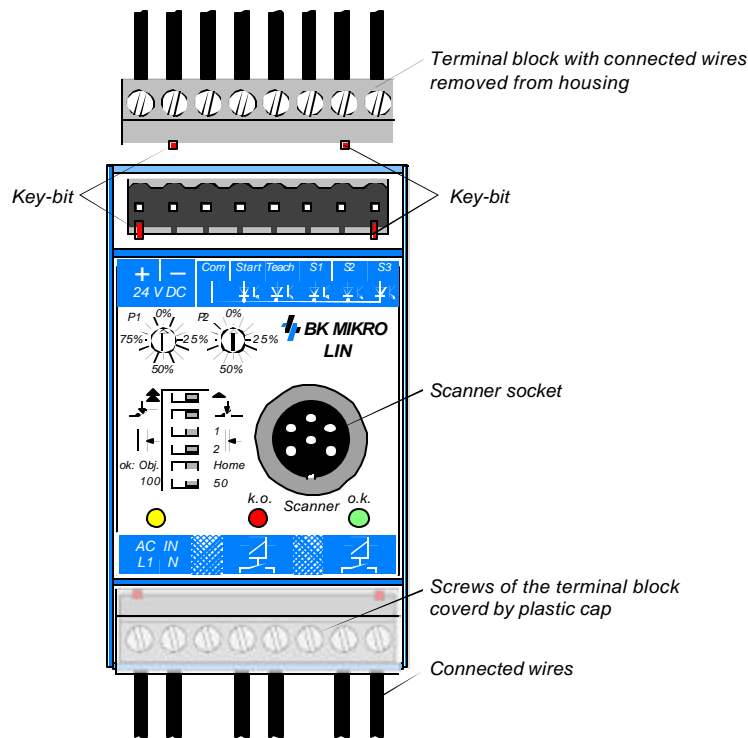

Fig. 2-1: Control unit – Front view with plug-in connections



Note:

These plugs may only be inserted or removed when the power supply has been disconnected.

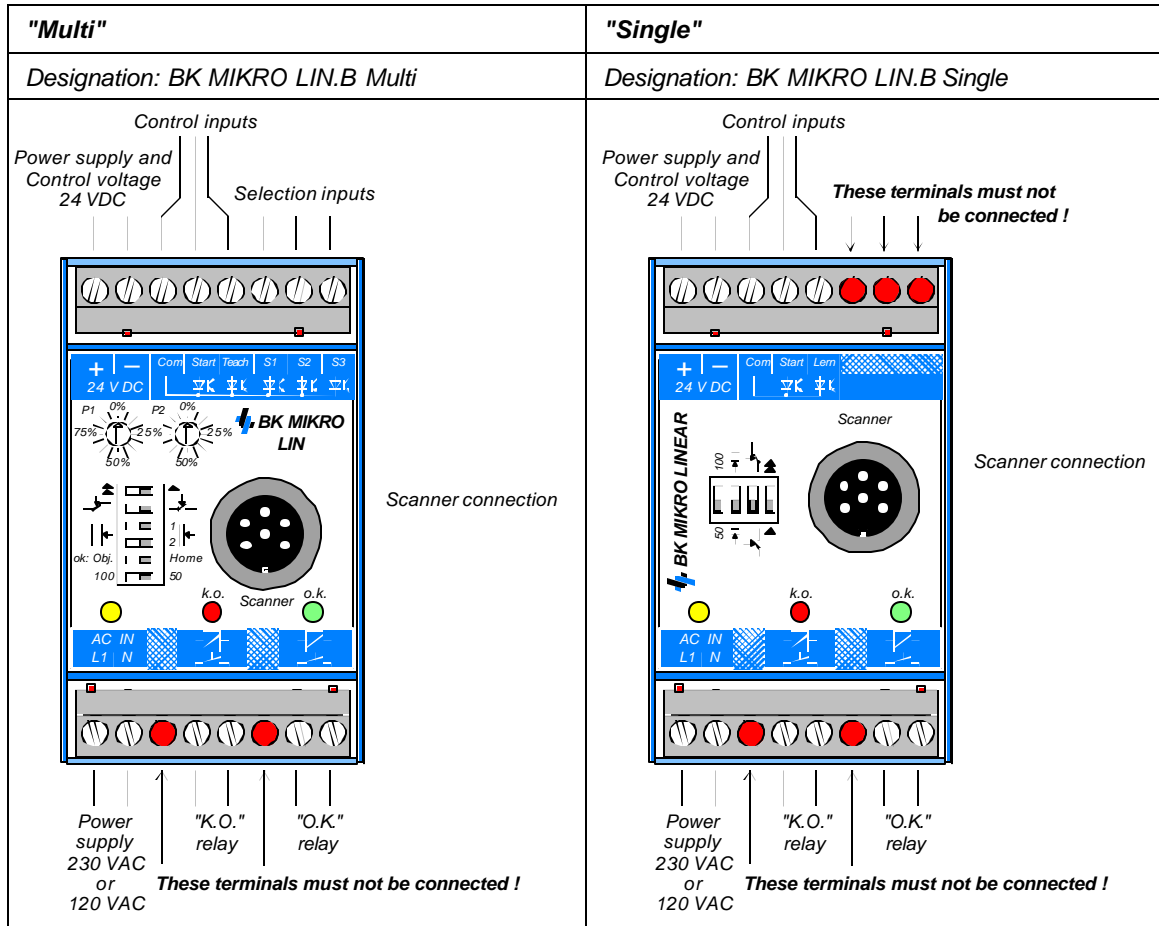

Fig. 2-2: Control unit – "Multi" and "Single"

Please note: New BK Linear Controllers are the same for Multi and Single

Features (due to the different control units)	"Multi"	"Single"
Number of toggle switches	6	4
2 steps for scanning intensity	x	X
Relay as N.C. or N.O. contact	x	X
Scanner TK50-LIN.B or TK100-LIN.B	x	X
Ranges of tolerance for "O.K." (referred to the learned position)	4	2
"O.K." message at "Object"	x	–
Rotary switches P1, P2	x	–
Selection inputs S1, S2, S3	x	–
Monitoring of a learned position: Teach mode	x	X
Tool monitoring / Object monitoring	P1=0, P2=0	Standard
Number of learned positions, which can be stored.	8	1
Monitoring of a preset range: Switch mode	P1 [≠] 0, P2 > 0	–
Object monitoring: "O.K.", if an object is detected.	S1=0	–
Free space monitoring: "O.K.", if no object is detected.	S1=1	–

Important: When applying power to S1, S2, and S3 the 24 volts must be delayed (50 ms) until the controller is fully powered up and done performing its internal operations.

2.1.1 Technical data

Housing	Insulating material housing, protection class II, built-in unit
Protection type	IP 20
Dimensions (W x H x D)	45 mm x 75 mm x 107.5 mm
Case mountings	Sectional rail, 35 mm, to DIN EN 50022
Power supply voltage (depending on model)	24 VDC $\pm 20\%$ PELV ¹⁾ $I_{max} = 0.25 A$ 120 VAC $I_{max} = 0.05 A$ 230 VAC $I_{max} = 0.025 A$
Power consumption	6 VA max.
Control voltage (int./ext.)	24 VDC $\pm 20\%$ PELV ¹⁾
Inputs	Galvanically isolated
– Input current	5 mA approx.
– Pulse duration	6 ms min.
Switched outputs	2 x 250 VAC / 30 VDC, 2 A max.
Making/breaking capacity	500 VA / 60 W (max.) 10 mA min. at 10 V
Operational life of relay	5×10^7 switching cycles
Connections	Plug-in screw terminals for connecting – power supply – control inputs – selection inputs (only for "Multi") – relay outputs Scanner socket to DIN 45322, 6 pin
Climatological conditions	Classification 3K3 under EN 50178
Ambient temperature	0 °C to +50 °C
Storage temperature	–25 °C to +80 °C

**Note:**

The control unit of BK MIKRO LIN.B is a **built-in unit!**

¹⁾ PELV = Protected Extra Low Voltage

The voltage applied must meet the requirements for an extra low function potential with safe disconnection (PELV).

Mechanical dimensions

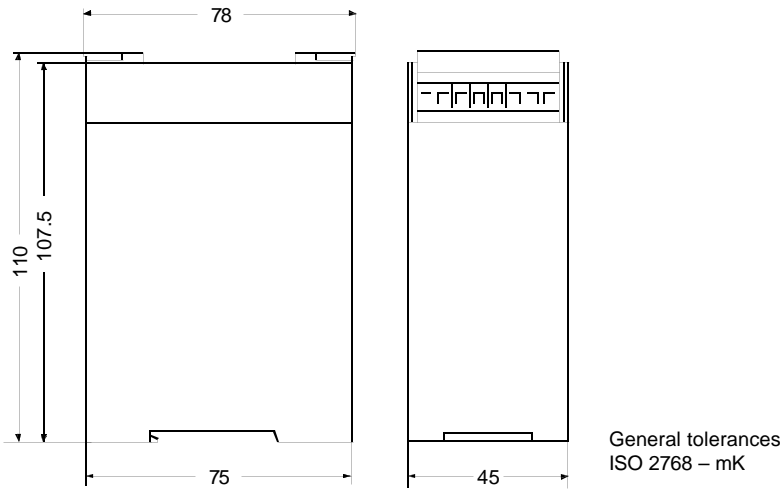

Fig. 2-3: Control unit – Dimensions

2.1.2 Connection terminals

Power supply

"24 VDC" model:

	+	Supply voltage input 24 VDC
	-	Reference potential of 24 VDC supply voltage

"120 VAC" and "230 VAC" models ²⁾:

	L1	Supply voltage input, depending on model: 120 VAC or 230 VAC
	N	Supply voltage input, depending on model: 120 VAC or 230 VAC
	+	Control voltage for "Start", "Teach" and S1, S2, S3 controlling inputs: 24 VDC unregulated output current 0.1 A max. If an ext. control voltage is applied, this terminal is not connected.
	-	When using the internal control voltage, this terminal must be connected to the "Com" control inputs terminal. If an ext. control voltage is applied, this terminal is not connected.
	See section "Control voltage connection" in chapter "Installation Notes".	

Note:



²⁾ Alternatively, "120 VAC" and "230 VAC" models may also be supplied with 24 VDC.

In this case, "L1" and "N" terminals must not be connected.

"+24 VDC" and "-24 VDC" terminals are to be connected as described above for "24 VDC" model.



Control inputs

 <p>"Multi"</p>	<p>Com Reference potential for control inputs and selection inputs</p> <p>Start An input level of +24 VDC relative to "Com" terminal will trigger a "Start" cycle (the real scanning process).</p>
 <p>"Single"</p>	<p>Teach An input level of +24 VDC relative to "Com" terminal will trigger a learn cycle (the "Teach-in").</p> <p><u>Note:</u> This terminal is marked "Lern" at the "Single" unit. In the following it will be designated also "Teach".</p>

Selection inputs

Only for "Multi"!

	<p>S1 The input signal (static) of +24 VDC relative to "Com" terminal must be stable during 50 ms min. before "Teach" or "Start".</p> <p>S2</p> <p>S3</p> <ul style="list-style-type: none"> • using "Teach mode" <ul style="list-style-type: none"> S1, S2, S3 for function "Multi Learn": 3 selection inputs = 8 coded scanning positions A maximum of eight positions can be binary coded via the three selection inputs. • using "Switch mode" <ul style="list-style-type: none"> S1 for dividing "Monitoring function": S1=0 : Object monitoring S1=1 : Free space monitoring <p>Inputs which are not used, remain open.</p> <p>Default: S1=0, S2=0, S3=0</p>
---	---

Relay outputs

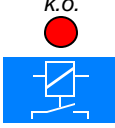
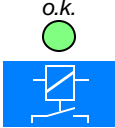

	K.O.	These two terminals are used to indicate a fault message (K.O.).
	O.K.	These two terminals are used to indicate a no fault message, i.e. a good cycle (O.K.).

The terminals have been designed as dry relay contacts. By switch selection, they may be configured as either normally open or normally closed.

The contacts have been designed for 250 VAC and, by additional internal circuits, protected against inductive switch-off peaks of up to 19 W (2 ms).

Note:



	Relay as normally closed contact:	active = open inactive = closed
	Relay as normally open contact:	active = closed inactive = open

When there is **no power** to the unit, the **contacts always** will be **open**.

Even when using relay as normally closed, they are open (like the active status) when the power supply is not connected.

2.1.3 Light-emitting diodes

Three light-emitting diodes (LEDs) on the front panel provide information about the current status of the BK MIKRO LIN.B monitoring system (see chapter "Status Indication"):

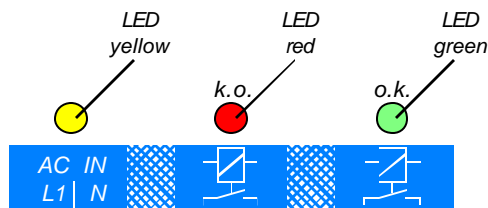





Fig. 2-4: Control unit – Light-emitting diodes

	yellow	Power supply / Status Indication of supply voltage and status
	red	"K.O." relay Indication of fault message
	green	"O.K." relay Indication of no fault message
	red/green	Error messages Indication of illegal switch settings

2.1.4 Rotary switches

Only for "Multi"!

The two rotary switches P1 and P2 are used to set the start position and the end position of the range, which is controlled by object monitoring or free space monitoring.

The position settings are possible in steps of 6.25%.

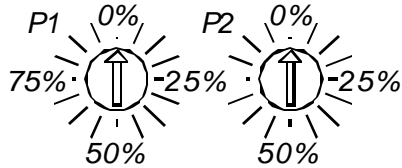

The figure shows the setup on delivery.

Fig. 2-5: Control unit – Rotary switches

Rotary switches	Meaning
$P1=0, P2=0$	Scanning with learn function
$P1 \neq 0$ $P2 > P1$ $P2 \leq 93.75$	Scanning with setting the scanning range: $P1 =$ start position $P2 =$ end position – No tolerances selectable – Selection input S1 for: Object monitoring $S1=0$ Free space monitoring $S1=1$



Illegal switch settings

- $P1=P2 \neq 0$ Error
 - $P1 \neq 0$ and $P2=0$ Error
- will cause flashing red and green LED.

2.1.5 Toggle switches

Using the toggle switches, the following functions may be set.

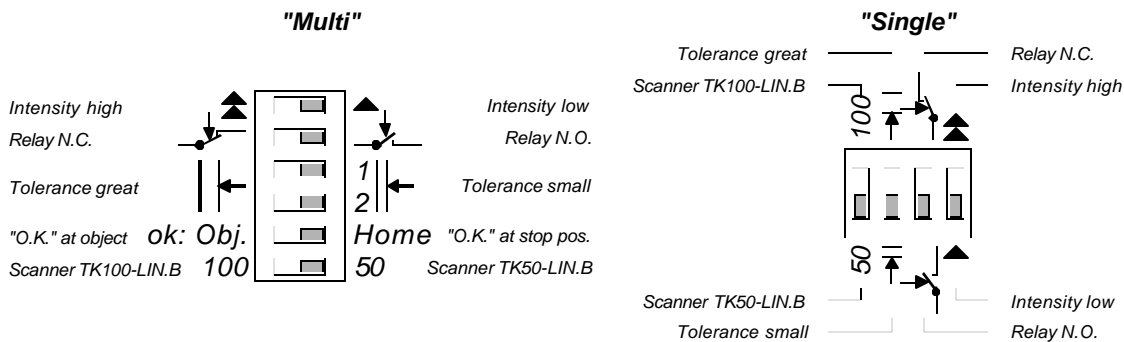

Fig. 2-6: Control unit – Toggle switches



Note:

The figure above shows the switch settings on delivery !

"Scanning intensity" switch

Speed and force of scanner's wand in its scanning range.

For "Teach-in" and "Start" cycle, in case of a good message, the impact force amounts to:

▲	approx. 5 N
▲▲	approx. 9 N

"Output relay" switch

Mode of operation for the two output relays (see section "Relay outputs").

	Relay N.O. (normally open contact)
	Relay N.C. (normally closed contact)

"Scanner" switch

Selection of the scanner.

50	Scanner with max. stroke of 50 mm
100	Scanner with max. stroke of 100 mm

"Tolerance range" switch(es)

Range of tolerance for "O.K." message referred to the position learned by "Teach-in".

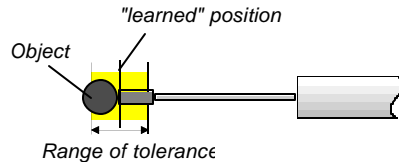

Fig. 2-7: Range of tolerance

"Multi"	"Single"	Tolerance [mm]
	—	0.32 (±0.16)
		1 (±0.5)
	—	2 (±1)
		10 (±5)

"O.K. indication" switch

Only for "Multi" !

"O.K." message can be output at different times.

Obj.	after detecting the object
Home	after reaching the stop position

2.1.6 Notes on technical safety



according to DIN VDE 160



according to EMC directive 89/336/EEC



for the models with power supply 24 VDC and 120 VAC

The control unit comprises the following circuits, all isolated from each other:

K.O. output (2 terminals)	safely isolated from all other circuits
O.K. output (2 terminals)	safely isolated from all other circuits
AC power supply (L1, N)	safely isolated from all other circuits
DC power supply (+24 V, -24 V)	safely isolated from K.O. output, O.K. output, and AC power supply
Control inputs (Com, Start, Teach)	safely isolated from K.O. output, O.K. output, and AC power supply
Selection inputs (S1, S2, S3)	safely isolated from K.O. output, O.K. output, and AC power supply
Scanner connections	safely isolated from K.O. output, O.K. output, and AC power supply
Inputs – control inputs (Com, Start, Teach) – selection inputs (S1, S2, S3) – Pulse inputs from scanner	opto-decoupled, no safely isolation from each other

2.2 Scanner

The scanner housing is cylindrical and smooth, thus permitting easy installation (e.g. by using a mounting bracket). The scanner is designed for easy access for servicing and changing the wand's tip. Aligning the scanner is easy and requires no additional instruments or aids.

After a supply voltage has been applied, the scanner travels from the momentary position to the internal backstop, moves into its stop position and will be held there by applying a low voltage.

Using the scanners with a different control unit than BK MIKRO LIN.B may damage the scanner and control unit.

Note:



- Due to its small diameter, a wand is easily overlooked.
- Your wand is a wearing part! Each contact with a rotating object will cause corresponding wear on the wand. This may even lead to the metal wand breaking.

Due to the injury hazard this causes, users should exercise particular caution within any BK MIKRO moving area.

2.2.1 Technical data

General

Housing	anodized aluminum
Protection type	IP 64
Scanning tip	exchangeable, thread M3x6
Connection to control unit	small circular connector M12x1, 6 pin
Ambient temperature	0 °C to +80 °C
Storage temperature	-25 °C to +85 °C
Scanning cycles	> 5 million at minimum scanning intensity

TK50-LIN.B

Control unit	- BKM LIN.B Multi "Scanner" switch set to "50" - BKM LIN.B Single "Scanner" switch set to "50"
Scanning range	50 mm max. stroke
Wand length	67 mm approx.

TK100-LIN.B

Control unit	- BKM LIN.B Multi "Scanner" switch set to "100" - BKM LIN.B Single "Scanner" switch set to "100"
Scanning range	100 mm max. stroke
Wand length	117 mm approx.

Mechanical dimensions

TK50-LIN.B = "50 mm max. stroke"

Requirement for correct monitoring: "Scanner" switch at control unit set to "50" !

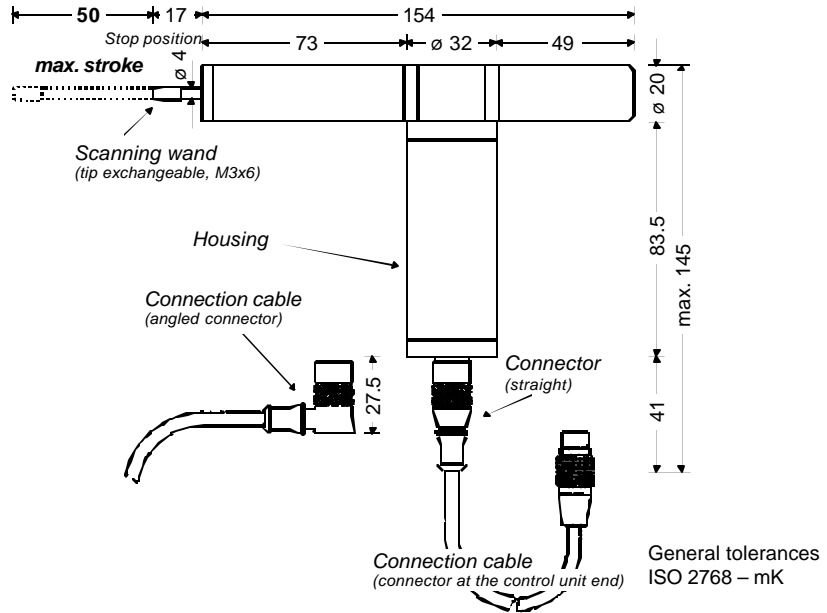

Fig. 2-8: Scanner TK50-LIN.B

TK100-LIN.B = "100 mm max. stroke"

Requirement for correct monitoring: "Scanner" switch at control unit set to "100" !

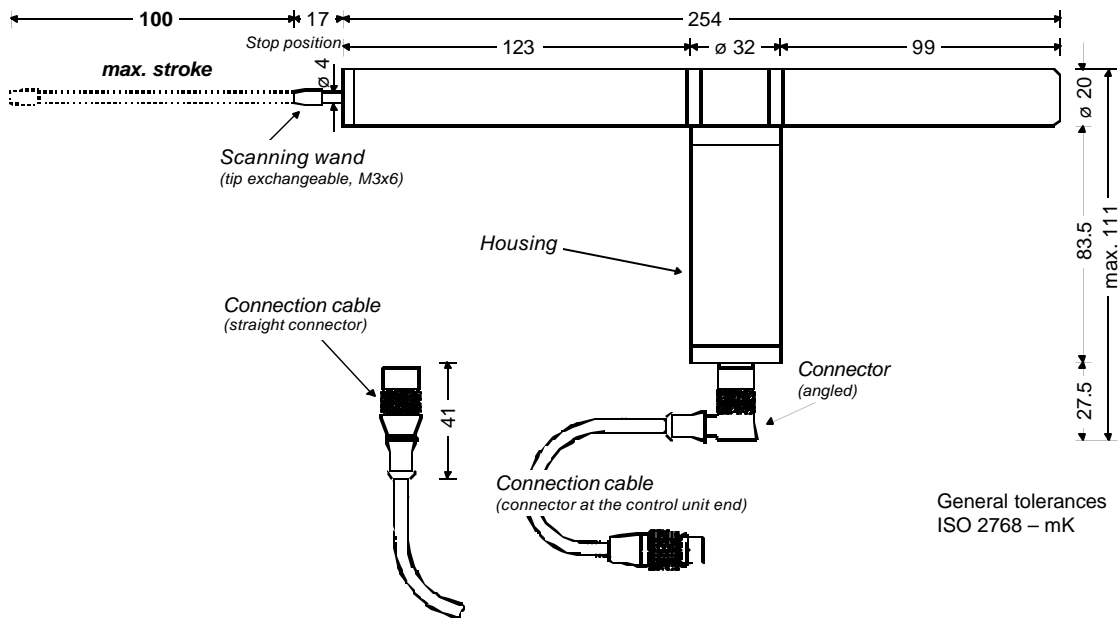
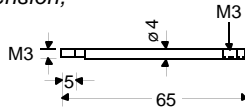

Fig. 2-9: Scanner TK100-LIN.B

2.2.2 Accessories

BK MIKRO LIN.B, all scanners !

Scanning tip extension,
M3



Scanner tip, brass

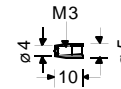

Adapter (with point of fracture
in case of damage),
M3

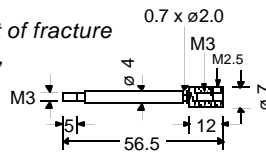

Scanner tip, plastic

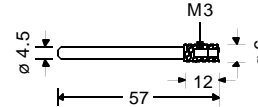

Wand holder

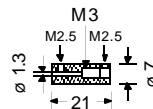
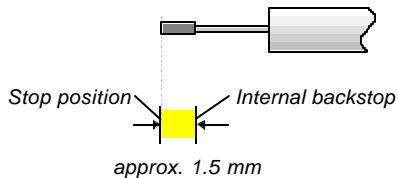

Fig. 2-10: Scanners – Accessories

2.2.3 Scanning Wand

Stop position



Stop position = Zero position of the wand

Stop position ≠ Internal backstop !

Fig. 2-11: Stop position of the wand



Note:

Do not push the wand back to its internal backstop (the real limit position) by hand.

This damages the gear !

Initial position

The tip of the wand is to be positioned at random between the object to be monitored and the internal backstop of the wand.

After supply voltage has been applied, and at the end of "Teach-in" or "Start" the wand will move into its stop position in any case.

Scanning range

Any scanning range between stop position and maximum stroke can be used.

Exchange the scanning tip

The tip can easily be removed from the wand (thread M3x6) and exchanged by a project-specific variant.

2.3 Connection cable

Control unit and scanner are connected by a 6-wire PUR-cable:

- Small circular connector to DIN 45322 at the control unit end.
- Molded plug at the scanner end.
- Length 5 m, can be extended to a maximum length of approximately 25 m with extension cables.

Pin configuration (at the control unit end)

Small circular connector to DIN 45322, 6 pin

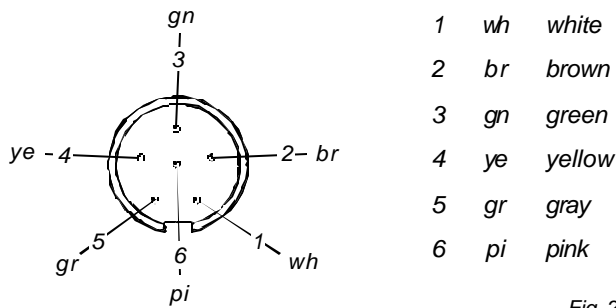

Fig. 2-12: Connection cable – Pin configuration

Note:



- To increase the operational life of this cable, it should not be subject to more than a minimum amount of movement during operating cycles.
- If this plug needs to be removed during fitting, please ensure that this pin configuration is followed on reassembly.

3 Mode of Operation

BK MIKRO LIN.B can be operated in different ways:

- *Monitoring with learn function (Teach mode), especially for "Multi": 8 different scanning positions can be binary coded.*
- *Monitoring with setting scanning range (Switch mode), possible only for "Multi".*
- *Monitoring as object monitoring or free space monitoring, possible only for "Multi".*

Return travel monitoring is always active.

3.1 Scanning process

Applying a pulse to "Start" or "Teach" terminal will trigger a scanning cycle. During scanning operation, both relay outputs will be inactive (LED for "O.K." and "K.O." not illuminated).

For the real scanning process, i.e. after a "Start" pulse, initially, the scanner will travel at maximum possible speed in forward direction to the start of a given monitoring range. However, its motor will slow down to a preselected scanning speed in time before a learned position using teach mode or a preselected angle set by rotary switch using switch mode is reached.

The monitoring range will then be traversed at the preset scanning speed and its related force, which is to be used to scan an object or range.

During the entire operation, all pulses generated by the scanner's internal encoder will be continuously processed.

If the system detects that the scanner no longer moves or has exceeded the end of the monitoring range, the direction of motion immediately changes, and the scanner will return at maximum speed into its stop position.

Depending on the result of scanning the "O.K." or the "K.O." relay will be activated, and the LED belonging to will indicate the result at the control unit.

3.2 Reference procedure when system is switched on

After supply voltage has been applied, the BK MIKRO LIN.B will carry out a self-test.

After that the system will run a reference procedure:

- *Travel to internal backstop*
- *Move into stop position*

3.3 Output of results

- **Fault message (K.O.)**

*A fault message will be output immediately on detection.
The scanner will return to its stop position.*

- **Good cycle message (O.K.)**

*On reaching the stop position, scanning process results will be indicated.
This ensures that the scanner will have left the monitoring range at the time the results are output and that there are no further waiting periods to be considered.*

Only for "Multi":

The indication of "O.K." is possible already after successful scanning, not only after reaching the stop position.

*In the "O.K." state, the "O.K." relay will be active,
while the "K.O." relay remains inactive.*

*In all other cases "K.O." will be indicated,
i.e. the "O.K." relay will be inactive,
the "K.O." relay will be active.*

Note:

"K.O." will not only be indicated when a tool has broken but also when the scanner cannot leave its stop position for any reason (e.g. mechanical "sticking", cable break etc.).

The results of a scanning cycle will remain latched until the following cycle starts.

3.4 Return travel monitoring

In case of non-attaining the stop position the "K.O." relay will be activated.

Return travel monitoring will detect malfunctions!



Example for suitable use of return travel monitoring:

BK MIKRO LIN.B has successfully monitored the object. But the wand is stopped by an obstacle on its return travel, cannot return into its stop position, and will block the transport of the tool.

Result with return travel monitoring	"K.O."	Machine stops!
---	---------------	-----------------------

4 Monitoring Functions

4.1 Teach mode = Monitoring with learn function

"Multi": One of the possible monitoring functions, requirement: P1=0, P2=0

"Single": Standard monitoring function

The scanning range will be determined by a learn cycle (external control signal).

This mode of operation is the typical mode for **tool detection** applications:

The system will check for the presence of the tool at the learned position.

4.1.1 "Teach-in", the learn cycle

Active input signal on the "Teach" screw terminal of the control unit.

The scanning wand moves with the preset speed from the current position to the mechanical backstop and then back in the opposite direction towards the object whose position is to be "learned".

- If a tool is detected, its position will be stored, and the scanner returns to its stop position with maximum speed. In addition, the "O.K." relay will be activated.
- If the scanning wand moves to its end of stroke without touching a tool, the "K.O." relay is activated. After a fault event of this kind, the position isn't stored any more. Following "Start" pulses will detect "K.O.".

The two LEDs for "O.K." and "K.O." will indicate the result.

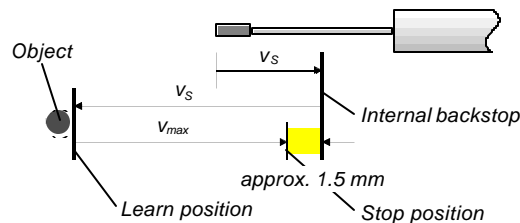

Fig. 4-1: "Teach-in", the learn cycle

Captions:

v_{max} = max. speed of scanner

v_s = speed of scanner preset by "Scanning intensity" toggle switch

$v_{s(low)} < v_{s(high)} < v_{max}$

Note:



The **position** learned during the "Teach-in" cycle **remains in memory** after system is switched off.

The **tool geometry** (position and dimension) during the "Teach-in" cycle must correspond to that during a "Start" monitoring cycle.

4.1.2 "Start", the real scanning process

Active input signal on the "Start" screw terminal of the control unit.

The scanner will travel to the previously "learned" position of the object to check for its presence.

- If the tool is within the monitoring range, the "O.K." relay will be activated.

The tolerance, admissible for a good cycle message (O.K.), can be set by "Tolerance range" switch(es).

Only for "Multi" !

Additionally there is the possibility to choose by setting the "O.K. indication" switch, whether the good cycle message is indicated already after detection of the object or – as with the "Single" – after reaching the stop position.

- If the tool is not detected, i.e. either it is missing or there is an obstacle within the scanner moving area, the "K.O." relay will be activated.

In addition, the two LEDs for "O.K." and "K.O." on the control unit indicate the result.

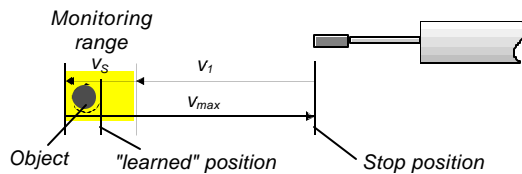

Fig. 4-2: "Start" cycle using "Teach mode"

Captions:

v_{max} = max. speed of scanner

v_1 = max. speed in forward direction

v_s = speed of scanner preset by "Scanning intensity" toggle switch

$v_{s(low)} < v_{s(high)} < v_1 < v_{max}$

4.1.3 Multi Learn

Only for "Multi" !

3 selection inputs = 8 coded scanning positions :

A maximum of eight positions can be binary coded via the three selection inputs.

- The input signal must be stable during 50 ms min. before "Teach" or "Start" to determine the position definitively.
- Each position has to be learned by "Teach-in" as described before.
- Inputs, which are not used, remain open.

Default: S1=S2=S3=0

4.2 Switch mode = Monitoring with setting the scanning range

Only for "Multi" !

Requirement: Rotary switches 0 £ P1 < P2 £ 93.75

Rotary switch P1 and P2 settings will define the scanning range, in steps of 6.25%.

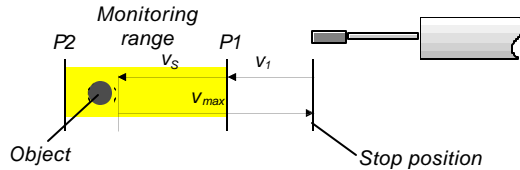

P1 = start position

P2 = end position

Fig. 4-3: "Start" cycle using "Switch mode"

Captions:

v_{max} = max. speed of scanner

v_1 = max. speed in forward direction

v_s = speed of scanner preset by "Scanning intensity" toggle switch

$v_{S(low)} < v_{S(high)} < v_1 < v_{max}$

Active input signal on the "Start" screw terminal of the control unit.
Pulse on the "Teach" terminal does not take effect.

4.2.1 Control operation "Object monitoring"

Requirement: Selection input S1=0 (not connected)

Using "Object monitoring", the control unit will change into an "O.K." state, i.e. it will issue a good message, if during a scanning cycle the operation sequence described below is followed:

- The scanner leaves its stop position.
- The position preset via rotary switch P1 has been exceeded.
- The position preset via rotary switch P2 has not been reached.

4.2.2 Control operation "Free space monitoring"

Requirement: Selection input S1=1

The control operation "Free space monitoring" differs from the object monitoring mode in that within its monitoring range no object must be detected.

Its "O.K." state is characterized by:

- The scanner leaves its stop position.
- The position preset via rotary switch P2 has been exceeded.



Caution:

When performing "Free space monitoring", a **broken wand** will always trigger an "O.K." signal.

4.2.3 Setting the position

The preset position results from the number of pulses, which the motor gives to the scanning wand through the gear. Therefore deviations in the device dimensions cause differences of the position.



Note:

BK MIKRO LIN.B is not an absolute measuring system !

Switch setting P1, P2	Position [in mm, approx.]	
	TK50-LIN.B	TK100-LIN.B
0 (only P1)	0	0
6.25	3.25	6.5
25	13	26
50	26	52
75	39	78
93.75 (only P2)	48.8	97.5

4.2.4 Example for range settings

Monitoring of a bore hole 35 mm deep using TK50-LIN.B:

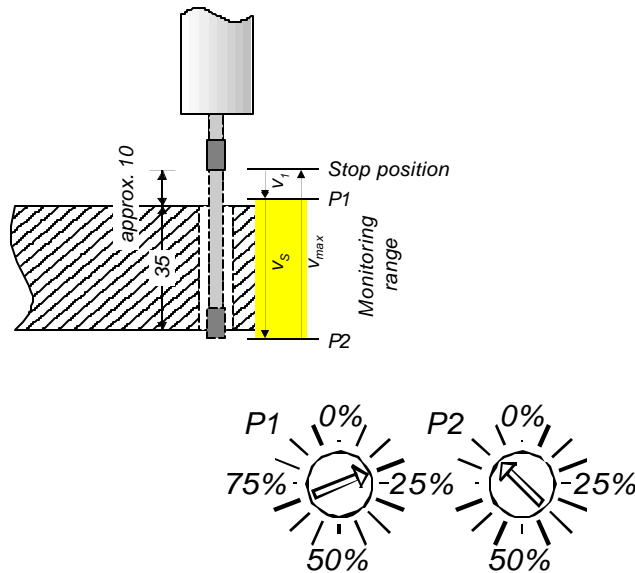

	P1	P2
Rotary switch	18.75%	87.5%
Position	9.75 mm	45.5 mm

Fig. 4-4: Range setting using rotary switches

5 Cycle Times

Scanning times

The following times designate the moment of the output of results after a scanning process.

They result with minimum tolerance.

Stroke	"Teach-in" <i>Intensity low Home O.K.</i>	"Teach-in" <i>Intensity high Home O.K.</i>	"Start" ¹⁾ <i>Intensity</i> ²⁾ <i>Home O.K.</i>	"Start" ¹⁾ <i>Intensity</i> ²⁾ <i>Obj. O.K.</i> ³⁾
10 mm	720 ms	410 ms	280 ms	170 ms
20 mm	1210 ms	670 ms	430 ms	270 ms
40 mm	2210 ms	1170 ms	740 ms	470 ms
90 mm	4700 ms	2440 ms	1510 ms	960 ms

Note:

- ¹⁾ For a "Start" cycle a greater range of tolerance will increase the values.
- ²⁾ For a "Start" cycle the setting of "Scanning intensity" is not decisive, because the monitoring range is small in comparison with the entire distance of moving (with minimum tolerance).
- ³⁾ "O.K. at object " only possible for "Multi".
This time corresponds to the time for indication of a fault message (K.O.) when object is missing.

6 Status Indication

6.1 Yellow LED

Fast flashing = Self-test

After power-up, the system will carry out a self-test indicated by fast flashing of this yellow LED.

Steady illumination = Ready to operate

Following its self-test, the system is ready to operate. The LED stops flashing and remains steady.

Slow flashing = Scanner fault

The system has detected a scanner fault:

- Scanner is missing or has motor fault.
- Control cable is not correctly connected, e.g. even cable break.

Outputs will be switched inactive; the unit will remain in its present state, indicated by slow flashing of this yellow LED.

6.2 Red LED / Green LED

Steady illumination = Indication following scanning cycle

The red LED indicates a fault message.

The green LED indicates a no fault message.

Flashing = Illegal settings

A flashing red and green LED simultaneously indicates that one or more of the switches is incorrectly set.

6.3 Error messages – Flashing red and green LED

Check the following P1 and P2 rotary switch settings to remove the error messages.

Teach mode [requires: P1=0, P2=0]	Error	Correction
for Learn cycle and "Start" cycle with learned position	$P1 \neq 0, P2 \neq 0$	$P1=0, P2=0$

Switch mode [requires: 0 ≤ P1 < P2 ≤ 93.75]	Error	Correction
Signal to "Teach" without effect, only "Start" pulse ! for object monitoring (S1=0) or for free space monitoring (S1=1)	$P2 = 0$	$P2 > 0$
	$P1 = P2$	$P1 < P2$
	$P1 > P2$	$P1 < P2$

7 Installation Notes

7.1 Control voltage connection

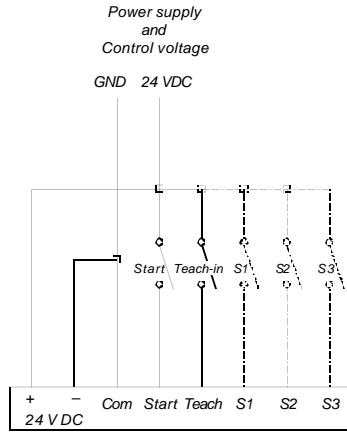

AC IN	K.O.	O.K.
L1 N	C NO/NC	C NO/NC

BK MIKRO LIN.B
24 VDC
common power and control voltage supply

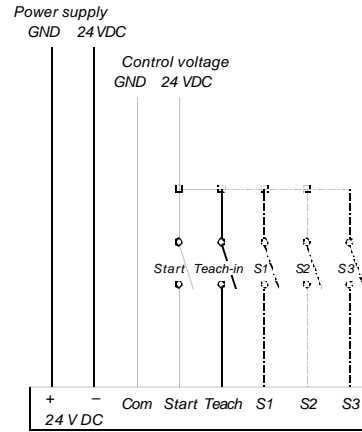

AC IN	K.O.	O.K.
L1 N	C NO/NC	C NO/NC

BK MIKRO LIN.B
24 VDC
separate control voltage

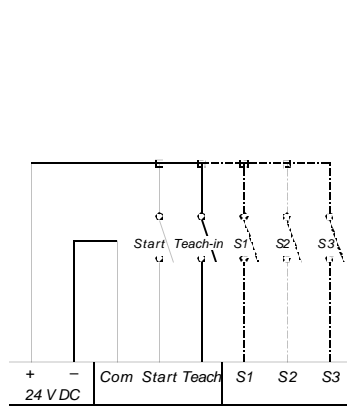

AC IN	K.O.	O.K.
L1 N	C NO/NC	C NO/NC

Power supply
BK MIKRO LIN.B
230 VAC (120 VAC)
internal control voltage

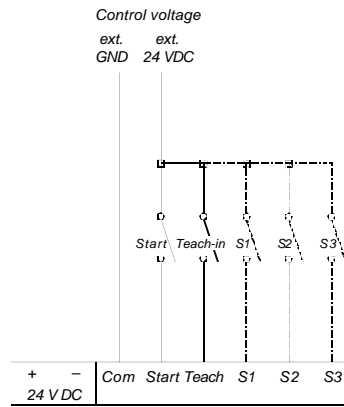

AC IN	K.O.	O.K.
L1 N	C NO/NC	C NO/NC

Power supply
BK MIKRO LIN.B
230 VAC (120 VAC)
external control voltage

Fig. 7-1: Control voltage connection

Connect selection inputs S1, S2, S3 only in case of use !

7.2 Mounting brackets

The delivering program offers two mounting brackets for the scanner as accessories.

Type	Article no.	Designation	Material
8.0070	61 07 082	Mounting bracket [ø 32 mm]	AlCuMgPb, F 38, 10 thick, naturally anodized
		2 cheese head screws with hexagonal hole M4x60	8.8 zincd
		2 self-securing nuts M4	8.8 zincd
 <p>General tolerances ISO 2768 - mK burred edges</p>			



Fig. 7-2: Mounting bracket [ø 32 mm]

Type	Article no.	Designation	Material
8.0770	61 07 165	Mounting bracket [ø 20 mm]	AlCuMgPb, F 38, 8 thick, naturally anodized
		2 cheese head screws with hexagonal hole M3x40	8.8 zincd
		2 self-securing nuts M3	8 zincd
<p>General tolerances ISO 2768 – mK burred edges</p>			

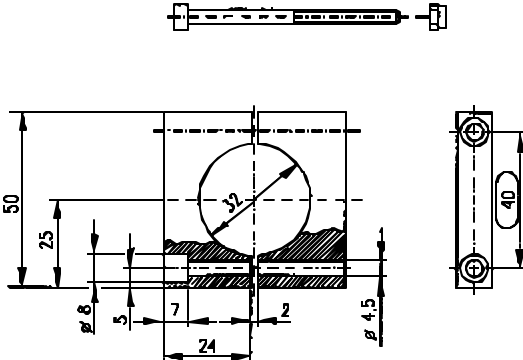
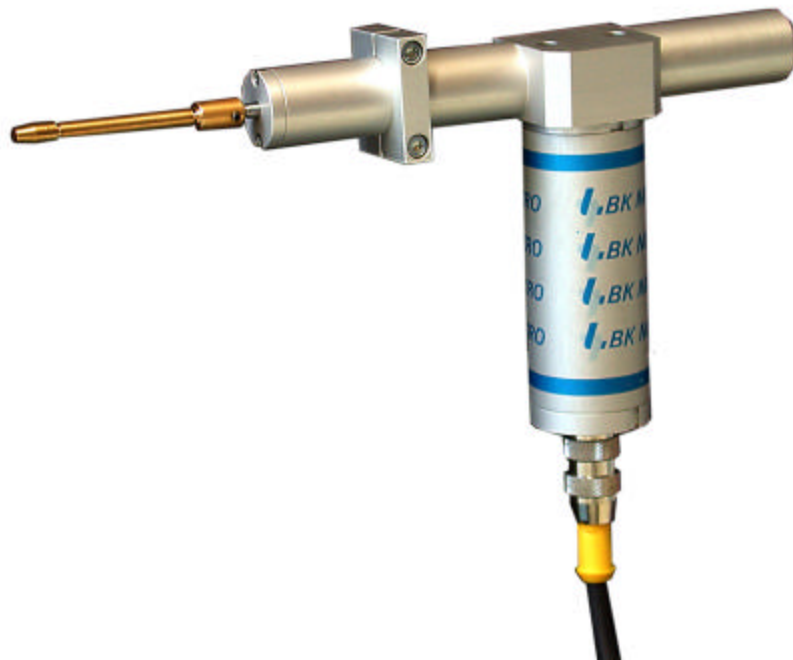

Fig. 7-3: Mounting bracket [ø 20 mm]

7.3 Interference prevention

All inputs are opto-decoupled and thus maximally protected against interference voltage peaks, as caused, for example, by inductive sources.

Relay outputs are protected by varistors against inductive interference voltage peaks. Depending on the type of load used, further interference suppression measures may be necessary.

To ensure optimum operational safety, suppression measures, if required, must be taken at source, i.e. directly where interference is caused.

Possible additional noise filters:



- RC combination (included in the contactor suppliers' product ranges)
- Varistors
- Diodes

Appendix A BK Linear Manufacturing and Techna-Tool Part Numbers

COMPLETE SYSTEMS:

BKLIN50 System BKLIN50SYS

(Includes BKLINSC/50, BKLINCTRL, BK5C5 and BKMB)

BKLIN100 System BKLIN100SYS

(Includes BKLINSC/100, BKLINCTRL, BK5C5 and BKMB)

COMPONENTS:

<u>Model#</u>	<u>Description</u>
<u>Scanners:</u>	
BKLINSC/50	scanner (TK50B-LIN.xx)
BKLINSC/100	scanner (TK100B-LIN.xx)
<u>Controller:</u>	
BKLINCTRL	Universal controller with 24 or 110 volt input (8.0705.xx, 6304227)
<u>Cable:</u>	
BK5C5	5 meter length; plug connector at scanner, plug connector at controller
<u>Bracket:</u>	
BKMB	Mounting Bracket , 50mm.sq. (2" sq.)

ACCESSORIES:

<u>Cables:</u>	BK5C5R	5 Meter length w/ right angle
	**BK5C10	10 Meter length cable
	**BK5C15	15 Meter length cable
	**BK5C20	20 Meter length cable

** Right angle connectors are available.

Extension Cables: (must be used with cable BK5C5 or BK5C5R)

BK5EC5	5 Meter length
BK5EC10	10 Meter length
BK5EC15	15 Meter length