



## Control System for Tool Breakage and Object Monitoring with PROFIBUS Interface and USB Interface

### Operating Instructions

Issue 1.0í

HĚ .2010



**Techna-Tool Inc.**  
553 S. Industrial Dr.  
Hartland, WI 53029  
Tel. 262-367-8665  
Fax 262-367-0208  
Email [techtool@techna-tool.com](mailto:techtool@techna-tool.com)  
Website [www.techna-tool.com](http://www.techna-tool.com)

**MSC Tuttlingen GmbH**  
Rudolf-Diesel-StraÙe 17  
D-78532 Tuttlingen  
Tel.+49 7461 925 200  
Fax+49 7461 925 268  
E-Mail [sales@msc-tuttlingen.de](mailto:sales@msc-tuttlingen.de)  
[www.bk-mikro.com](http://www.bk-mikro.com)





## General Notice

### Safety guidelines

This document contains notices which you should observe to ensure your own personal safety, as well as to protect the product and connected equipment. These notices are highlighted in the manual by a warning triangle and are marked as follows according to the level of danger.



#### **Immediate danger**

to life and limb of personnel and others.  
Non-compliance will cause death or serious (crippling) injury.



#### **Hazardous situation**

to life and limb of personnel and others.  
Non-compliance may cause death or serious injury.



#### **Potentially hazardous situation**

Non-compliance may cause slight injury;  
possible damage to property.



#### **Notes on correct handling**

Non-compliance may cause damage to the product and/or to parts/items in the vicinity.  
Important information about the product, the handling of the product, or the part of the documentation onto which is supposed to be made especially attentive.



#### **Environmental protection**

Non-compliance may have an impact on the environment.

### Intended use



The products of MSC Tuttlingen GmbH may only be used for the applications described in the technical documents, and only in connection with devices or components from other manufacturers which have been approved or recommended by us.

Start-up must not take place until it is established that the machine which is to accommodate this component conforms to the guideline 98/37 EC.

This product can only function correctly and safely if it is transported, stored, set up, and installed correctly, and operated and maintained as recommended.

**Qualification of personnel**

Only qualified personnel may carry out the following activities on the products: installation, commissioning, operation, maintenance.

Qualified persons in accordance with the safety guidelines are defined as persons who are authorized to commission, to ground, and to tag circuits, equipment, and systems in accordance with established safety practices and standards.

**Disclaimer of liability**

We have checked the contents of this document for agreement with the hardware and software described. Since deviations cannot be precluded entirely, we cannot guarantee full agreement. However, the data in this manual are reviewed regularly and any necessary corrections included in subsequent editions. Suggestions for improvement are welcomed.

**EMC directive 2004/108/EC**

The following applies to this product of MSC Tuttlingen GmbH:



BK MIKRO9 complies with the requirements of the EMC directive 2004/108/EC on basis of the standards following in chapter "Technical Data".

The EC declarations of conformity and the related documentation will be maintained at the following address for inspection by the responsible officials in accordance with article 10(1) of the above stated EC directive:

MSC Tuttlingen GmbH  
Rudolf-Diesel-Straße 17  
78532 Tuttlingen  
Germany

**Areas of use**

Products of MSC Tuttlingen GmbH meet the applicable, harmonized, European standards for the respective area of applications.

**Warranty**

For the devices of MSC Tuttlingen GmbH, the agreements determined in the General Terms and Conditions (AGB) are valid.

**Fitting conditions**

The fitting conditions and safety notes in the submitted document must be adhered to when commissioning and operating the products.

**Trade names and/or trademarks**

All hardware and software names are trade names and/or trademarks of the respective manufacturer.

**Copyright**

Every user documentation is intended for the operator and the operator's personnel only. The transmission and reproduction of this document and the exploitation and communication of its contents are not allowed without express authority. Offenders will be liable for damages.

## Contents

<b>1</b>	<b>Characteristics .....</b>	<b>5</b>
1.1	Overview Control Units .....	6
1.2	Overview I/O Expansion Module.....	7
1.3	Overview Scanners .....	8
<b>2</b>	<b>System Components .....</b>	<b>10</b>
2.1	Control Unit .....	10
2.1.1	Characteristic properties .....	10
2.1.2	Connection terminals .....	11
2.1.3	LEDs to indicate status information .....	13
2.1.4	PROFIBUS interface .....	14
2.1.5	USB connection .....	14
2.1.6	Scanner connection .....	14
2.2	I/O Expansion Module.....	15
2.2.1	Characteristic properties .....	15
2.2.2	Connection terminals .....	16
2.2.3	Light-emitting diodes (LEDs).....	18
2.2.4	Rotary switch.....	19
2.3	Scanner .....	23
2.3.1	Characteristic properties .....	23
2.3.2	Scanner TK7A and TK7RL .....	25
2.3.3	Scanner TK8A.....	26
2.3.4	Scanner TK91A .....	27
2.3.5	Balance weights for TK91A .....	28
2.3.6	Scanner TK94A and TK94RL.....	29
2.3.7	Scanner TK96A and TK96RL.....	31
2.3.8	Mounting bracket and holding arm for TK96A/TK96RL.....	32
2.3.9	Scanner TK9LIN50/100 .....	33
2.4	Exchanging of the Scanning Wand.....	35
2.5	Air Barrier Adapter .....	36
2.6	Connection cable .....	37
<b>3</b>	<b>Operating Modes.....</b>	<b>38</b>
3.1	Operating Mode PROFIBUS-DP.....	38
3.1.1	Address setting .....	38
3.1.2	General function sequence .....	39
3.1.3	Scanning in one direction.....	39
3.1.4	Activation of the tool table (PC configuration software BK MIKRO9).....	41
3.1.5	Scanning in both directions (only via PROFIBUS).....	41
3.1.6	Reference travel.....	42
3.1.7	Time-optimized scanning .....	43
3.1.8	GSD File.....	45
3.1.9	PROFIBUS DP Protocol .....	45
3.1.10	PROFIBUS data format.....	46
3.2	Operating Mode Digital I/O .....	58
3.2.1	Switch mode = monitoring scanning range with switch settings.....	59
3.2.2	Control operation "Object monitoring".....	59
3.2.3	Control operation "Free space monitoring" .....	59
3.2.4	Output of results.....	60
3.3	Function Mini-USB .....	61
<b>4</b>	<b>Technical Data.....</b>	<b>62</b>
4.1	Control Unit .....	62
4.2	I/O Expansion Module.....	63
4.3	Scanner TK7A and TK7RL .....	64
4.4	Scanner TK8A.....	65

---

4.5	Scanner TK91A.....	66
4.6	Scanner TK94A.....	67
4.7	Scanner TK96A and TK96RL.....	68
4.8	Scanner TK9LIN50 .....	69
4.9	Scanner TK9LIN100 .....	70
4.10	Accessories .....	71
4.10.1	Scanning wand set.....	71
<b>5</b>	<b>Installation Notes .....</b>	<b>72</b>
5.1	Interference prevention .....	72
<b>6</b>	<b>Ordering Information .....</b>	<b>73</b>

## Table of Figures

Fig. 1-1:	Overview BK MIKRO9 Control Unit – Front and rear side .....	6
Fig. 1-2:	Overview BK MIKRO9 I/O Expansion Module – Front and rear side .....	7
Fig. 1-3:	Overview Scanner – TK7A / TK7RL .....	8
Fig. 1-4:	Overview Scanner – TK8A.....	8
Fig. 1-5:	Overview Scanner – TK9 .....	9
Fig. 2-1:	BK MIKRO9 Control Unit – Front side with connections .....	11
Fig. 2-2:	BK MIKRO9 Control Unit – Connection positions.....	11
Fig. 2-3:	Light-emitting diodes.....	13
Fig. 2-4:	PROFIBUS-DP interface.....	14
Fig. 2-5:	I/O Expansion Module – Connections .....	15
Fig. 2-6:	I/O Expansion Module – Connections positions.....	15
Fig. 2-7:	I/O Expansion Module – Digital outputs.....	17
Fig. 2-8:	I/O Expansion Module – Light-emitting diodes .....	18
Fig. 2-9:	I/O Expansion Module – Rotary switch.....	19
Fig. 2-10:	I/O Expansion Module – Toggle switches .....	20
Fig. 2-11:	Definition of the rotation direction .....	21
Fig. 2-12:	Range of tolerance.....	22
Fig. 2-13:	Scanner TK7A / TK7RL .....	25
Fig. 2-14:	Scanner TK8A.....	26
Fig. 2-15:	Scanner TK91A with 3 balance weights .....	27
Fig. 2-16:	Dimensions in mm with 3 balance weights.....	28
Fig. 2-17:	Dimensions in mm with 2 different balance weights.....	28
Fig. 2-18:	Dimensions in mm with 3 different balance weights.....	28
Fig. 2-19:	Scanner TK94A / TK94RL .....	29
Fig. 2-20:	Option: Air barrier light connection TK94A / TK94RL .....	30
Fig. 2-21:	Scanner TK96A / TK96RL .....	31
Fig. 2-22:	Scanner TK96A / TK96RL .....	32
Fig. 2-23:	Dimensions Mounting Bracket / Holding arm .....	32
Fig. 2-24:	Scanner TK9LIN50 .....	33
Fig. 2-25:	Option: compressed air balance TK9LIN50/100.....	34
Fig. 2-26:	Scanner TK91A – blind plug.....	35
Fig. 3-1:	Function sequence.....	39
Fig. 3-2:	"Start" cycle with CW travel .....	40
Fig. 3-3:	Scanning CW / CCW .....	41
Fig. 3-4:	Time-optimized scanning – Preposition.....	43
Fig. 3-5:	Time-optimized scanning – "Collision-free area" .....	44
Fig. 3-6:	Time-optimized scanning – "Time frame" .....	44
Fig. 3-7:	Distance .....	56
Fig. 3-8:	"Start" cycle with scanning in both directions .....	58
Fig. 4-1:	Mechanical Dimensions – Control Unit BK MIRKO9 .....	62
Fig. 4-2:	Mechanical Dimensions – I/O Expansion Module .....	63
Fig. 4-3:	Mechanical Dimensions – Scanner TK7A / TK7RL.....	64
Fig. 4-4:	Mechanical Dimensions – Scanner TK8A .....	65
Fig. 4-5:	Mechanical Dimensions – Scanner TK91A .....	66
Fig. 4-6:	Mechanical Dimensions – Scanner TK94A .....	67
Fig. 4-7:	Mechanical Dimensions – Option Air barrier light adapter .....	67
Abb. 4-8:	Mechanische Abmessungen – Tastkopf TK94A.....	68
Fig. 4-9:	Mechanical Dimensions – Scanner TK9LIN50.....	69
Fig. 4-10:	Mechanical Dimensions – Option compressed air connection.....	69
Fig. 4-11:	Mechanical Dimensions – Scanner TK9LIN100.....	70
Fig. 4-12:	Mechanical Dimensions – Option compressed air connection.....	70
Fig. 4-13:	Scanner – Accessories .....	71

**Purpose**

These operating instructions are part of the documentation of the BK MIKRO9. They provide service personnel and system advisors with the information required to install, commission, operate and maintain the system BK MIKRO9.

© Copyright MSC Tuttlingen GmbH, 78532 Tuttlingen, 2010  
These operating instructions are available as article no. **68 36 263**.  
Subject to change without notice.



## 1 Characteristics

BK MIKRO9 is a control system suitable for tool as well as for object and free space monitoring applications.

The complete BK MIKRO9 system comprises

- a control unit (I/O expansion module option),
- a sensor (scanner),
- a connection cable,
- various optional accessories.

BK MIKRO9 can be used universally for different types of monitoring by the integration of multifarious functions:

- Operation with PROFIBUS-connection.  
Monitoring occurs with parameter specification (angle/tolerance etc.) of the PROFIBUS-Master (SPS/PLC). With this mode of operation the full scope of device function is available.
- Operation with digital I/Os – Setting parameters with help of a PC.  
Parameters of the tool object data are created on a PC, transferred to the control unit via USB, and digitally controlled (SPS) in the application. In connection with the extension module, up to 512 objects/tools can be learned and checked via selection inputs. With this mode of operation the full scope of function is available as well.
- Operation with digital I/Os – Setting parameters via toggle switches.  
For easy setup without using the PC software all of the important functions can be set using the dip switches on the extension module. The selection of up to 512 possible objects/tools from using the SPS as well.

### Principle of operation

The scanner wand controls in a specified area the object positions or angles in the machine.

A micro-computer based control unit triggers the wand movement by an external signal or signal from PROFIBUS-Master (PLC). The result of measurement will be checked with the stored value in the control unit (before certain via TEACH or different parameters) and triggers an "OK" or "KO" message according to the result. This message will be outputted to the relays contact (digital I/Os) or the PROFIBUS. As required can activate every deviation an immediate machine stop. Through that are avoided consequential damages of the machine and parts.

The galvanically isolated inputs and outputs guarantee a high degree of operational safety and protection against interferences.

### Further features

- Scanning in clockwise (CW) or counter-clockwise (CCW) direction
- 8 steps for scanning intensity
- Output relay contacts selectable as normally open or normally closed
- Ranges of tolerance for "OK" message adjustable
- Scanning results indicated by two LEDs "OK" and "KO" on the control unit
- Detection of cable breaks
- Configuration software for program setting and tool data
- Various movement functions of the scanning wand
- Use of various scanners for different applications

1.1 Overview Control Units

BK MIKRO9		
Device type	Front and rear side	Connections
<p><b>BK MIKRO91 Premium</b> with Profibus interface</p>	 <p>Dimensions: 22.6 mm x 99 mm x 113.6 mm</p>	<ul style="list-style-type: none"> <li>- PROFIBUS interface</li> <li>- Mini USB</li> <li>- Digital inputs</li> <li>- Relay outputs</li> <li>- Scanner connection</li> <li>- 3 connection terminals</li> <li>- Opening for top-hat rail connector</li> </ul>
<p><b>BK MIKRO92 Premium</b> without Profibus interface</p>	 <p>Dimensions: 22.6 mm x 99 mm x 113.6 mm</p>	<ul style="list-style-type: none"> <li>- Mini USB</li> <li>- Digital inputs</li> <li>- Relay outputs</li> <li>- Scanner connection</li> <li>- 3 connection terminals</li> <li>- Opening for top-hat rail connector</li> </ul>
<p><b>BK MIKRO93 Basic</b> without Profibus interface</p>	 <p>Dimensions: 22.6 mm x 99 mm x 113.6 mm</p>	<ul style="list-style-type: none"> <li>- Mini USB</li> <li>- Digital inputs</li> <li>- Relay outputs</li> <li>- Scanner connection</li> <li>- 3 connection terminals</li> <li>- Opening for top-hat rail connector</li> </ul>

Fig. 1-1: Overview BK MIKRO9 Control Unit – Front and rear side

## 1.2 Overview I/O Expansion Module

BK MIKRO9		
Device type	Front and rear side	Connections / switches
BK MIKRO9 I/O Expansion Module		<ul style="list-style-type: none"> <li>- Digital I/Os</li> <li>- Toggle switches</li> <li>- Rotary switch</li> <li>- 4 connection terminals</li> <li>- Top-hat rail connector</li> </ul>
	Dimensions: 22.6 mm x 99 mm x 113.6 mm	

Fig. 1-2: Overview BK MIKRO9 I/O Expansion Module – Front and rear side

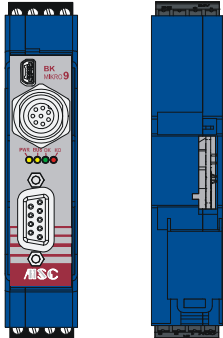
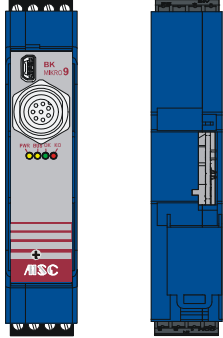
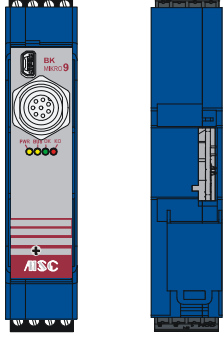
### 1.3 Overview Scanners

BK MIKRO 7		
Device type	Scanner	Connection cable
<b>Scanner – TK7A / TK7RL</b> (without cable)	 <p>Wand length: 165 mm</p>	<ul style="list-style-type: none"> <li>- Straight connector, 8 pin, 5 m</li> <li>- Angled connector, 8 pin, 5 m</li> <li>- Straight connector, 8 pin, 15 m</li> <li>- Angled connector, 8 pin, 15 m</li> </ul>

Fig. 1-3: Overview Scanner – TK7A / TK7RL

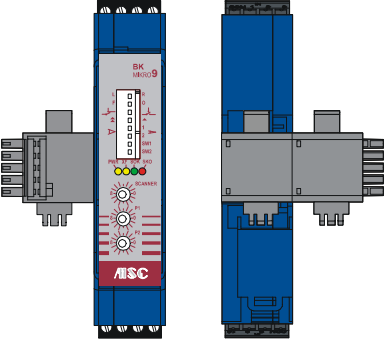
BK MIKRO 8		
Device type	Scanner	Connection cable
<b>Scanner – TK8A</b> (incl. wand holder, without wand, without cable)	 <p>Wand length: 380 mm</p>	<ul style="list-style-type: none"> <li>- Straight connector, 8 pin, 5 m</li> <li>- Angled connector, 8 pin, 5 m</li> <li>- Straight connector, 8 pin, 15 m</li> <li>- Angled connector, 8 pin, 15 m</li> </ul>

Fig. 1-4: Overview Scanner – TK8A

BK MIKRO <sup>9</sup>		
Device type	Scanner	Connection cable
<p><b>Scanner – TK91A</b> (incl. wand holder, without wand, without cable)</p>	 <p>Wand length: 610 mm</p>	<ul style="list-style-type: none"> <li>- Straight connector, 8 pin, 5 m</li> <li>- Angled connector, 8 pin, 5 m</li> <li>- Straight connector, 8 pin, 15 m</li> <li>- Angled connector, 8 pin, 15 m</li> </ul>
<p><b>Scanner – TK94A / TK94RL</b> (without cable)</p>	 <p>Wand length: 165 mm</p>	<ul style="list-style-type: none"> <li>- Straight connector, 8 pin, 5 m</li> <li>- Angled connector, 8 pin, 5 m</li> <li>- Straight connector, 8 pin, 15 m</li> <li>- Angled connector, 8 pin, 15 m</li> </ul>
<p><b>Scanner – TK9LIN50/100</b> (without cable)</p>	 <p>Maximum stroke: of 50 / 100 mm</p>	<ul style="list-style-type: none"> <li>- Straight connector, 8 pin, 5 m</li> <li>- Angled connector, 8 pin, 5 m</li> <li>- Straight connector, 8 pin, 15 m</li> <li>- Angled connector, 8 pin, 15 m</li> </ul>
<p><b>Scanner – TK96A / TK96RL</b> (with fixed cable of 210 mm)</p>	 <p>Wand length: 100 mm</p>	<ul style="list-style-type: none"> <li>- Straight connector, 8 pin, 5 m</li> <li>- Angled connector, 8 pin, 5 m</li> <li>- Straight connector, 8 pin, 15 m</li> <li>- Angled connector, 8 pin, 15 m</li> </ul>

Fig. 1-5: Overview Scanner – TK9

## 2 System Components

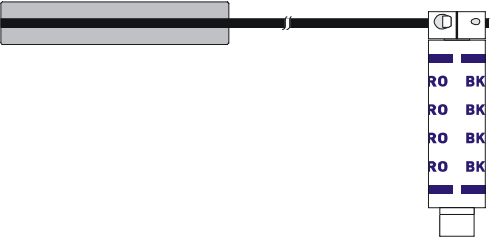
### 2.1 Control Unit

Three versions of control units are offered:

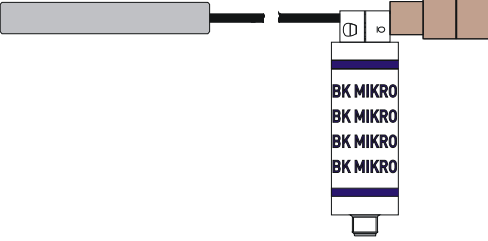
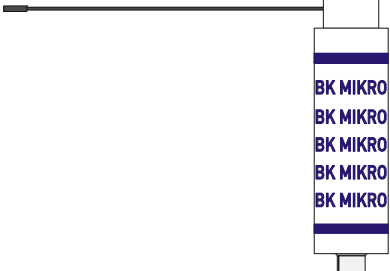
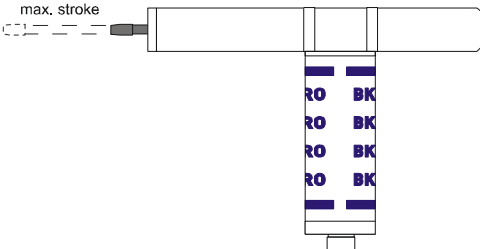
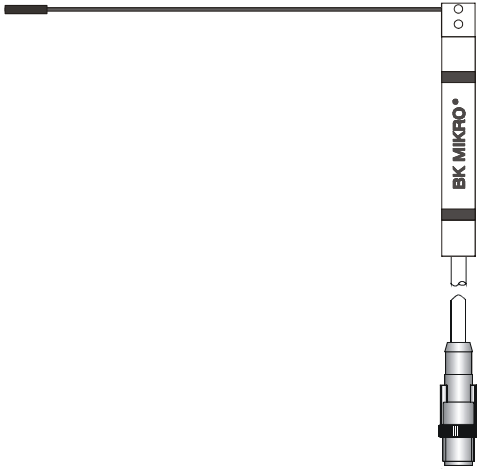
- BK MIKRO91 Premium – with PROFIBUS interface: all functions
- BK MIKRO92 Premium – without PROFIBUS interface: all functions
- BK MIKRO93 Basic – without PROFIBUS interface: reduced function range for simple handling

#### Functionality overview

Control Unit	PROFIBUS	Function I/O Module	Number of the functions	Features	Reduction
BKM91 Premium	X	- Toggle / Rotary switches - 2 Outputs - 10 Inputs	512	All	None
BKM92 Premium	–	- Toggle / Rotary switches - 2 Outputs - 10 Inputs	512	All	None
BKM93 Basic	–	- Toggle / Rotary switches - 1 Output	1	Only CheckObj and FreeSpace	Intensity Return travel Outputs No area adjustments Parameter reduction

#### 2.1.1 Characteristic properties

The BK MIKRO9 system control unit is housed in an protection class II insulating housing.

On the top and bottom side, the control unit is fitted with plug-in screw terminals to connect all machine inputs and outputs, supply voltage, and the scanner.

The scanner will be connected via a 8-wire cable to the scanner socket of the control unit.



The BK MIKRO9 control unit – build-in device for switch cabinets – is designed for supply voltage 24VDC. Other supply voltages can damage the device.

2.1.2 Connection terminals

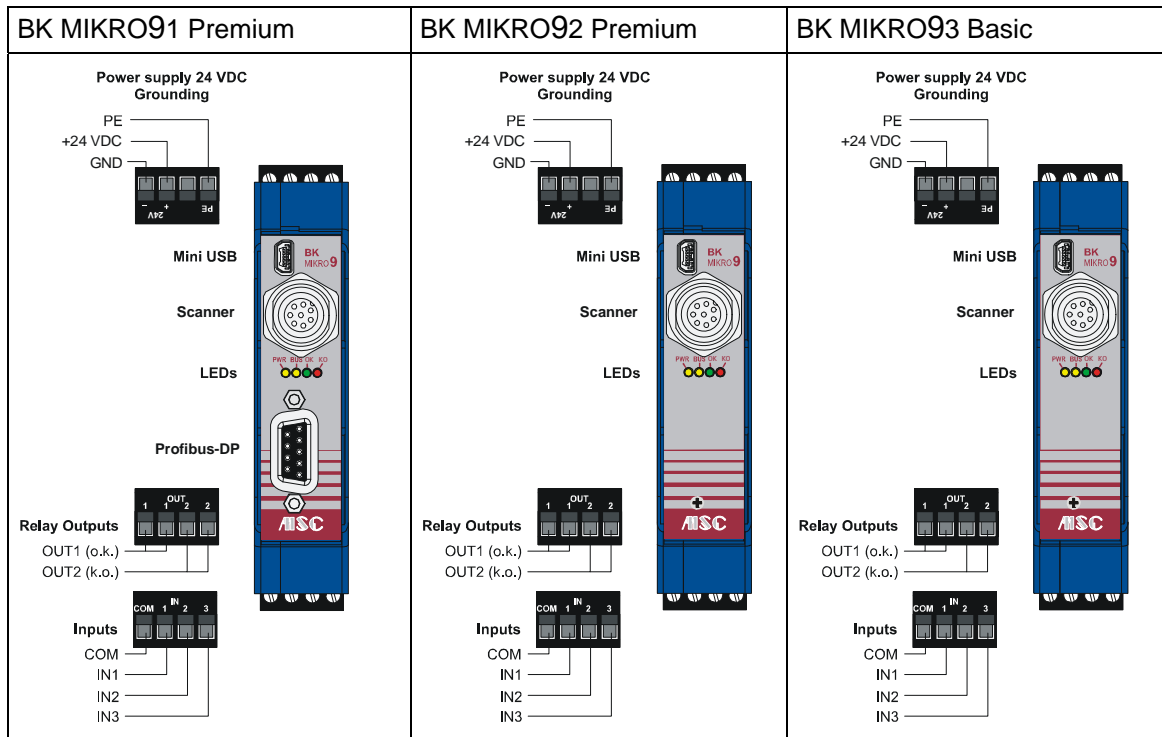

Fig. 2-1: BK MIKRO9 Control Unit – Front side with connections



**Note:**

These plugs may only be inserted or removed when the power supply has been disconnected.

These blocks are keyed so that they cannot be accidentally plugged into the wrong socket.



**Note:**

The nominal tightening torque for the clamping screws of the terminal connectors should be 0.5 – 0.6 Nm or 4.4 – 5.3 pound-inches (lbf in).

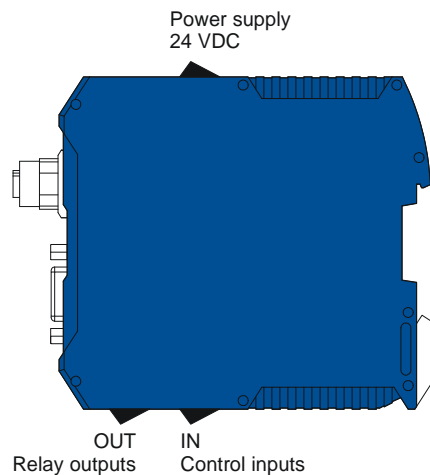
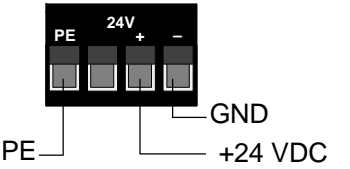

Fig. 2-2: BK MIKRO9 Control Unit – Connection positions

**24V – power supply 24 VDC**

	<b>+</b>	Input of 24 VDC supply voltage
	<b>-</b>	Reference potential of 24 VDC supply voltage
	<b>PE</b>	Connection to earth potential



**Mains supply voltage 24 VDC**

24 VDC supply for integrated DC/DC transducer.

The voltage applied must meet the requirements for a safe extra low voltage (SELV) according to EN 60950!

Attend to "+" and "-" polarity!

**OUT – relay outputs**

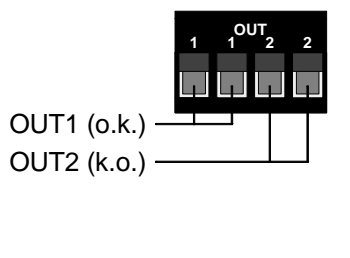
	<b>1</b>	<b>Relay 1 (OK)*</b> Indication of a no fault message (OK) (2 terminals)
	<b>2</b>	<b>Relay 2 (KO)*</b> Indication of a fault message (KO) (2 terminals)

\* Default configuration of the control unit.

The terminals are dry relay contacts.

By internal parameters, they may be configured via PC-Software, PROFIBUS or BK MIKRO9 expansion modules as either normally closed or normally open.

The contacts have been designed for 24 VDC and are protected by additional internal circuits against inductive switch-off peaks of up to 19 W (2 ms).



**Note:**

Relay as normally closed contact: active = open  
inactive = closed

Relay as normally open contact: active = closed  
inactive = open

When there is **no power** to the unit, the **contacts always** will be **open**.

**Even when using relay as normally closed**, they are open (like the active status) when the power supply is not connected.



**IN – control inputs**

	<b>COM</b>	Reference potential for control inputs and selection input
	<b>1</b>	<b>"Teach" - control input</b> An input level of +24 VDC relative to "COM" terminal will trigger a "Teach". The position stored during the "Teach" will remain stored even after the unit has been switched off.
	<b>2</b>	<b>"Start" - control input</b> An input level of +24 VDC relative to "COM" terminal will trigger a "Start" cycle (the real scanning process).
	<b>3</b>	<b>Stop - control input</b> An input level of +24 VDC relative to "COM" terminal will trigger a "Stop" (an operation will be disconnected).

The inputs can be connected with positive or negative logic.

Positive logic:

- COM input must be put on GND.
- The particular input (IN 1 – 3) will be set on 24 V (high) by switching.
- As low-condition the input will be wired on GND or left open.

Negative logic :

- COM input must be put on 24 V.
- The particular input (IN 1 – 3) will be set on 0 V (high) with switching.
- Considered low-condition the input will be connected to 24 V or left open.

**2.1.3 LEDs to indicate status information**

Four light-emitting diodes (LEDs) on the front panel of the BK MIKRO9 control board are used to indicate status information.

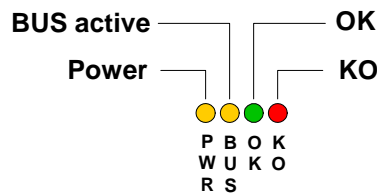

Fig. 2-3: Light-emitting diodes

LED	Color	Designation	Function	Status
PWR	Yellow	Power	Power supply 24 VDC	On
BUS	Yellow	BUS active	USB active	On
			Data transmission (USB/PROFIBUS)	Flashing
			Bus not active	Out
OK	Green	OK	Scanning "OK"	On
KO	Red	KO	Scanning "KO"	On

### 2.1.4 PROFIBUS interface

The PROFIBUS interface is a floating RS-485 interface (electrically insulated).

A standard 9 pin Sub-D socket is used for the plug.

The pin assignment of the 9 pin Sub-D socket corresponds to PROFIBUS standard.

Sub-D socket, 9 pin	Pin	Signal	Function
	1	N.C.	not connected
	2	N.C.	not connected
	3	RxD/TxD-P	Data line B
	4	RTS	Request To Send
	5	GND	Data reference potential
	6	5V	5 VDC
	7	N.C.	not connected
	8	RxD/TxD-N	Data line A
	9	N.C.	not connected

Fig. 2-4: PROFIBUS-DP interface

### 2.1.5 USB connection

Connection to the PC is established via a USB plug located on the front side of the control unit. A common USB cable (mini-B) is used.

### 2.1.6 Scanner connection

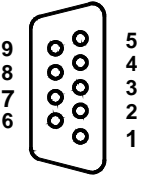
The scanner is connected to the 8-pole M12 circular plug-in connector with the control-cable in the control unit front.

## 2.2 I/O Expansion Module

### 2.2.1 Characteristic properties

The BKM9I/O expansion module is used if several inputs- or outputs are needed and or to configure control the control unit directly without using PROFIBUS or USB.

The module will be connected with the control unit via top-hat rail connector. It will supply power to the control unit, which means no additional power supply is needed. The module offers 10 additional inputs, 2 digital outputs, several trigger switches and 3 rotary switches. Four LEDs are used for status-/error display.

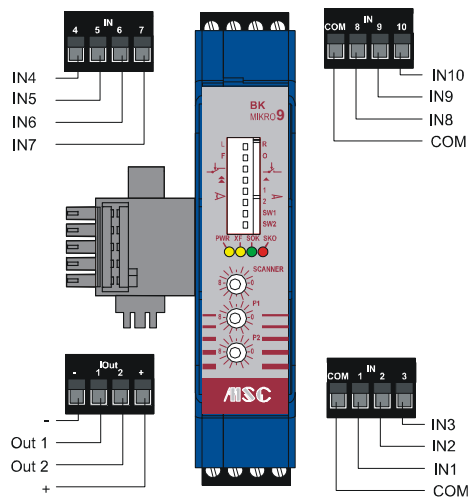

Fig. 2-5: I/O Expansion Module – Connections



**Note:**

These plugs may only be inserted or removed when the power supply has been disconnected.

Uncharacterized clamps must be blank.



**Note:**

The nominal tightening torque for the clamping screws of the terminal connectors should be 0.5 – 0.6 Nm or 4.4 – 5.3 pound-inches (lbf in).

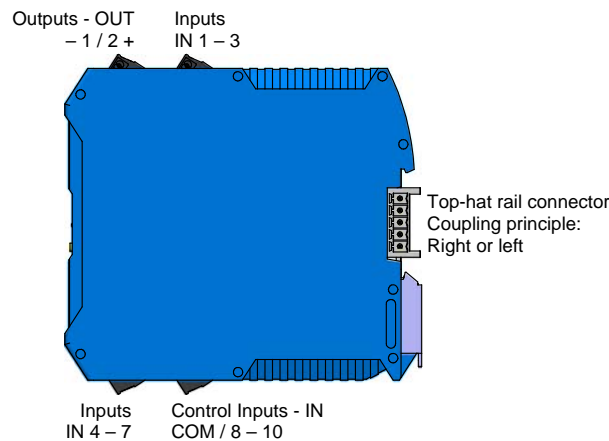

Fig. 2-6: I/O Expansion Module – Connections positions

## 2.2.2 Connection terminals

### Control inputs

The I/O expansion module has a total of 10 additional digital inputs. 9 inputs are used for selecting the function to be started. The input 10 can be used to reset the outputs of the BK MIKRO9 control unit and the BK MIKRO9 expansion module.

The function numbers selected via the inputs are from 0 to 511.

These control inputs cannot be used with the BK MIKRO93 basic control unit and can be connected using either positive or negative logic.

Positive logic:

- COM input must be put on GND.
- The particular input (IN 1 – 3) will be set on 24 V (high) by switching.
- As low-condition the input will be wired on GND or left open.

Negative logic :

- COM input must be put on 24 V.
- The particular input (IN 1 – 3) will be set on 0 V (high) with switching.
- Considered low-condition the input will be connected to 24 V or left open.

Unnecessary selection inputs may remain open. A signal must be applied for at least 40 ms to be effective.

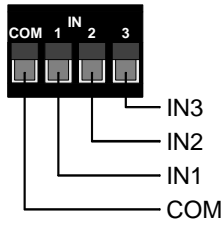
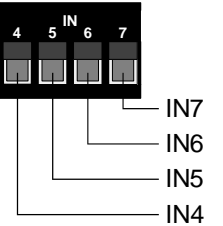
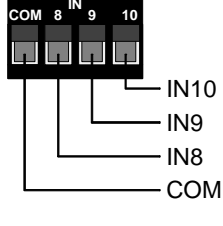
	<b>COM</b>	Reference potential of inputs IN 1 – 3 Connect positive logic with GND Connect negative logic with 24 V
	<b>1</b>	<b>Selection input 1</b>
	<b>2</b>	<b>Selection input 2</b>
	<b>3</b>	<b>Selection input 3</b>
	<b>4</b>	<b>Selection input 4</b>
	<b>5</b>	<b>Selection input 5</b>
	<b>6</b>	<b>Selection input 6</b>
	<b>7</b>	<b>Selection input 7</b>
	<b>COM</b>	Reference potential of control inputs 8 – 10. This inputs may remain open if 8 – 10 are not used. Positive logic: GND Negative logic: 24 V
	<b>8</b>	<b>Selection input 8</b>
	<b>9</b>	<b>Selection input 9</b>
	<b>10</b>	<b>Reset input of outputs</b> Outputs (e.g. OK, KO) can be reset with this input.

Through the 9 selection inputs 512 different tool positions can be saved and monitored.

The selection of the tool positions is done using in a binary pattern, this means that through activating and deactivating the different positions can be called up.

e.g. Tool position	Selection inputs								
	S9	S8	S7	S6	S5	S4	S3	S2	S1
0	L	L	L	L	L	L	L	L	L
23	L	L	L	L	H	L	H	H	H
176	L	H	L	H	H	L	L	L	L
511	H	H	H	H	H	H	H	H	H

L  $\hat{=}$  Low

H  $\hat{=}$  High

**Digital outputs**

Two additional configurable active digital outputs are available with the I/O extension module.

Only this digital output is not available in connection with the BK MIKRO93 basic control unit (for counter alarm).

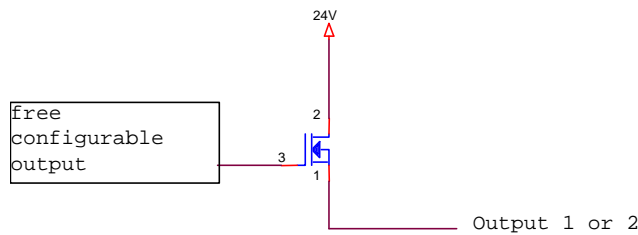

Fig. 2-7: I/O Expansion Module – Digital outputs

The outputs are high-side-switches, which means that, they act like normal switches: Either they actively switch 24V (max. 0,5 A) on the output or the output is unused.

	-	<b>Reference potential of the outputs (GND)</b>
	1	<b>Output 1</b>
	2	<b>Output 2</b>
	+	<b>24V power supply</b>

### 2.2.3 Light-emitting diodes (LEDs)

Four LEDs on the front panel provide information about the current status of the expansion module BK MIKRO9:

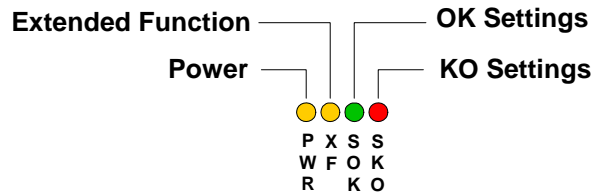

Fig. 2-8: I/O Expansion Module – Light-emitting diodes

LED	Color	Designation	Function	Status
PWR	Yellow	Power	Power supply 24 VDC	On
XF	Yellow	PROFIBUS address	PROFIBUS address (Rotary switch) I/O Expansion module active	Out
SOK	Green	OK settings	Signal for right switch settings	On
SKO	Red	KO settings	Signal for wrong switch	On

### 2.2.4 Rotary switch

The "SCANNER" rotary switch is used for selecting the scanning head. A selection between 1 and 10 can be made. Position 15 is reserved for automatic scanner detection. Position 0 means that the PROFIBUS-address can be set via P1 and P2.

If the scanner switch is not set at 0 then the P1 and P2 rotary switches are used to manually set the position or area that is going to be checked for an object or for free space monitoring. These switches set the position via angle that the wand needs to travel to (P1) and how far it travels to (P2) before it outputs an OK or KO signal. These switches do not need to be used if you are "teaching" the objects position.

The smaller P1 / P2 value determines the start of the monitoring area and the bigger value of P1 / P2 indicates the end of the monitoring area.

The settings are possible in steps of 24.0° (from 0.0° to 360.0°).

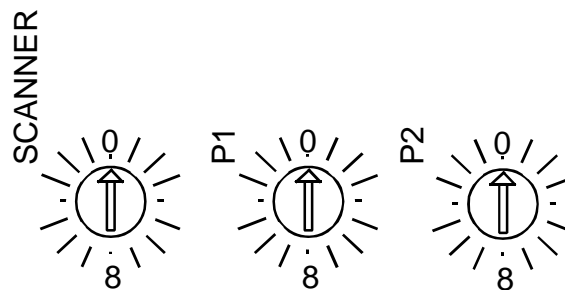

Fig. 2-9: I/O Expansion Module – Rotary switch

Selection of the scanners:

0	PROFIBUS setting	P1 and P2 display the PROFIBUS address. Toggle switch are inactive.
1	TK8A	Scanner TK8A (Scanner with backstop)
2	TK7A	Scanner TK7A (Scanner with backstop)
3	TK8A Short Wand	Scanner TK8A with short wand (Scanner with backstop)
4	TK91A	Scanner TK91A (Scanner with backstop)
5	TK91A Fastlong	Scanner TK91A (Scanner without backstop)
6	TK94A/RL	Scanner TK94A/RL (Scanner with and without backstop)
7	TK9LIN50/100	Scanner TK9LIN50/100
8	TK Reserved 1	-
9	TK Reserved 2	-
10	TK Reserved 3	-
15	TK Autodetect	The scanner is recognized automatically.

The illustration shows the factory settings.



**Invalid switch settings**

P1=P2 Error

cause red LED on the control unit to light.

**Setting the profibus address via P1 and P2**

With the scanner selection = 0 via P1 and P2 the profibus address can be set in connection with the BK MIKRO91 control unit. The internally memorized address in the control unit is not regarded.

Settings via P1 and P2 are hexadecimal. With P1 the rather significant bits are set and with P2 the less significant are set.

Example: Address 50dec = 32hex → P1 = 3, P2 = 2

**Toggle switches**

The following functions can be set using the rows of eight toggle switches on the front panel of the control unit.

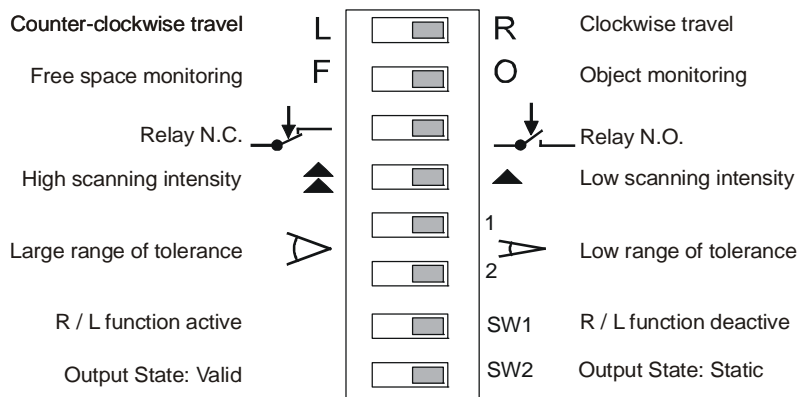

Fig. 2-10: I/O Expansion Module – Toggle switches



**Note:**

Settings at delivery: All switches are on the right side!

Only with the scanner setting unequal 0 all switches are active. There's a the higher priority as the saved parameters in the control unit.



**Right / Left switch**

Rotation direction of the scanning wand, i.e. direction in which the wand moves from the rest position.



**Right =**

**Rotation clockwise**

Rear view (of the cable connection side) on the scanning head, in the direction of the axis of rotation.

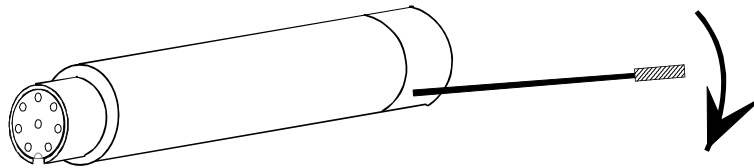

Fig. 2-11: Definition of the rotation direction

**"Object / Free space monitoring" switch**

"OK" message for

- presence (object monitoring) or
- object not present (free space monitoring) in the scanning range.

**"N.C. / N.O. contact" switch**

Functionality of the 4 outputs (see section "Digital outputs").

**"Scanning intensity" switch**

Adjusts the speed and force of the scanning wand within the scanning range.

For the "Teach" and the "Start" cycle where an OK message should be received, this is:

Switch position "Scanning Intensity"	Impact force
▲	small
▲▲	large



**Note:**

If this switch is in the "small" position, the reduced impact force helps to protect the wand against wear.

**"Tolerance range" switch**

Tolerance range for "OK" message, in relation to the target position, i.e, the position taught by "Teach" or the position set using switches:

1-off, 2-off (small)	±0.1°
1-on, 2-off	±1.0°
1-off, 2-on	±3.0°
1-on, 2-on (large)	±10.0°

\* on = switch position left  
 \* off = switch position right

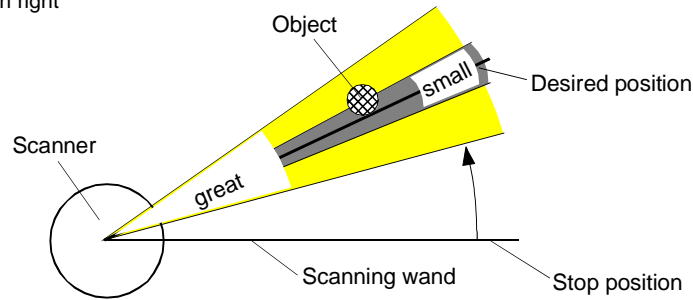

Fig. 2-12: Range of tolerance

**SW1 switch**

The wand is between two objects. With SW1 is activated the CW/CCW scanning, with "Teach" the wand travels first to left object and then to the right object. When a start input is given both objects are scanned.

**New Tool Settings:**

With the RL-function 128 different RL tool kits (left and right tool) are available. The tool selection occurs from the selection inputs of the I/O modules IN3 to IN8.

About IN1 and IN2 can be determined the scanned tool:

IN2	IN1	Tool
0	0	The right and the left tool are scanned
0	1	The right tool is scanned
1	0	The left tool is scanned
1	1	The left and the right tool are scanned

At a "Teach" both tools must always be present.

**SW2 Output State switch**

When set to "Valid" the outputs are momentary or only active as long as the "Teach" or "Start" signals are held high, when the signal drops the output opens or closes depending on its setting. When set to "Static" the outputs are latched and stay in that state until the next "Teach" or "Start" signal is given.

## 2.3 Scanner

### 2.3.1 Characteristic properties

The scanner housing is cylindrical and smooth, which permits easy installation (e.g. by using the mounting bracket). The scanner is designed for easy access for servicing and changing of the wand. Aligning the scanner is easy and requires no additional instruments or aids.

The scanner listed below can be connected to the BK MIKRO9 control unit.  
Following chart shows the main features:

Type	Axis (Ø)	Unit (Ø)	High (mm)	Scanning wand length max. (mm)	Plate	Time of 180° rotation (approx. sec)	Repeat accuracy max. (+/-°)
TK7A/RL*	3 mm	20 mm	79 mm	250 mm	No	0.4 s	1.2
TK8A*	3 mm	20 mm	79 mm	380 mm	Yes	1.3 s	0.15
TK91A*	4 mm	32 mm	107.5 mm	610 mm	Yes	1.8 s	0.05
TK94A/RL*	4 mm	32 mm	117.5 mm	250 mm	No	0.25 s	1.2
TK96A/RL*	3 mm	12 mm	90.5 mm	100 mm	No	0.25 s	1.2
				Hub length max.		Time of 1 hub (approx. sec.)	Repeat accuracy max. (mm)
TK9LIN50	–	32 mm	103.5 mm	50 mm	–	1.4 s	0.05
TK9LIN100	–	32 mm	103.5 mm	100 mm	–	1.8 s	0.05

\* Type description:

- A ⇒ Scanner with wand holder backstop  
(no external dead stop for home positioning necessary).
- RL ⇒ Scanner, capable of right/left run  
(with external backstop or controlling of two tools simultaneously).

A customized set of the motor-parameters may be necessary for demands that differ from the denoted wand lengths or scanning times in the chart above. Please contact the producer if the values listed above are exceeded.

The scanner can be selected with the configuration software or by using the rotary switch of the expansion module. Parameter values and technical data are listed below.

If a scanner does not match the control unit setting, the scanner type needs to be altered in the control unit before connecting. Movement can occur due to different resolution and gear ratios. This may result in maximum overstepping and damage to the scanner.

**Note:**

Connecting a scanner which does not correspond to the settings of the control unit, can damage the scanner.

**Note:**

Wrong scanner parameters lead to wrong measurement results.

**Note:**

At scanners with an internal stop it is possible, if an angles is  $>270^\circ$ , that the internal stop will be travel and a wrong "OK" will be trigger.

That applies also with the TK9LIN50 and TK9LIN100 scanners, if they travel in the full area.

### Automatic recognition of the scanners

The TK9 series scanner are recognized automatically with the "TK Autodetect" parameter setting (Parameters 6, scanner): no special adjustments are necessary via PROFIBUS, the PC software or the expansion module, if „TK Autodetect“ is selected. At delivery „TK Autodetect“ is adjusted. .

**Note:**

The TK7A/RL and TK8A scanners can not be recognized automatically.

If "TK Autodetect" is active and no TK9 series scanner of the is connected, then the TK8A scanner will be automatically set, i.e. only the TK7A/RL scanner must be set via PROFIBUS, PC software or the expansion module.

### 2.3.2 Scanner TK7A and TK7RL

We offer two types of scanners for the different applications.

The only difference between the two scanners is that the rotary movement of TK7A wand is limited by a screw inside the housing. This screw is the mechanical backstop.

#### TK7A – Scanner with mechanical backstop

Scanner for scanning in one direction: clockwise or counter-clockwise

#### TK7RL – Scanner without mechanical backstop

Scanner for scanning in both directions: CW-CCW or CCW-CW, in special cases for scanning in one direction: CW or CCW



#### Note:

- Due to its small diameter the wand is easily overlooked.
- Your wand is a wearing part! Each contact with a rotating object will cause wear on the wand. That can break the wand, and the wand must be changed.
- For rotation tools an especially hardened HSS steel wand is available.

To avoid injury users should exercise caution while working in the area that the BK MIKRO wand travels.

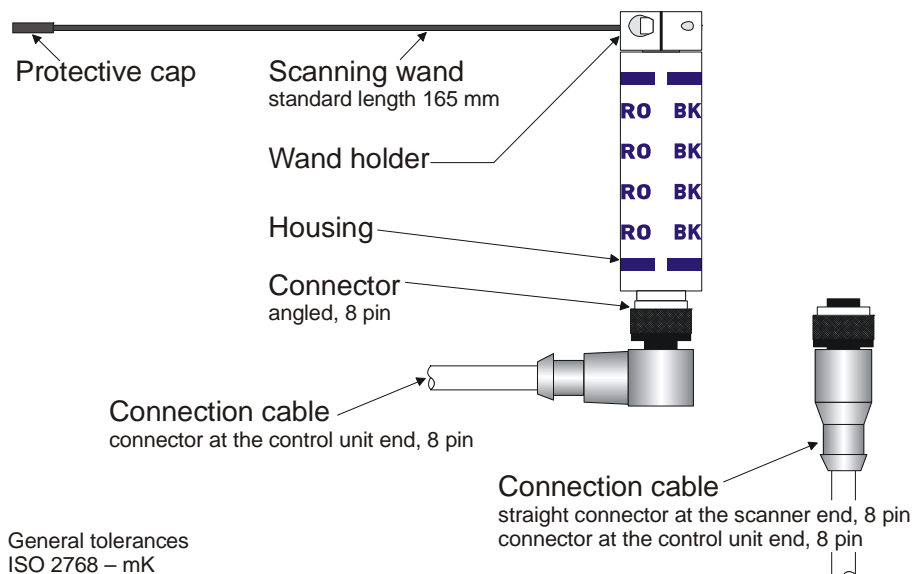

Fig. 2-13: Scanner TK7A / TK7RL



#### Note:

To prevent possible injury, the wand is supplied with a protective cap.

### 2.3.3 Scanner TK8A

#### The TK8A scanner offers two special features:

- Scanning wands are available in lengths up to 380 mm  
This allows for greater distances between the scanner and tools or objects that it is checking.
- Scanning plate on the scanning wand  
This makes it possible to use the scanner directly in the tool magazine to make positive contact with the tool's tip.

The TK8A scanner has a mechanical backstop that limits the rotary movement of the wand. Using the TK8A scanner with a different control unit than the BK MIKRO9 may damage the scanner and control unit.



#### Note:

**Wrong scanner parameters lead to incorrect measurement results.**



#### Note:

The wand is a wearing part.

**To avoid injury users should exercise caution while working in the area that the BK MIKRO wand travels.**

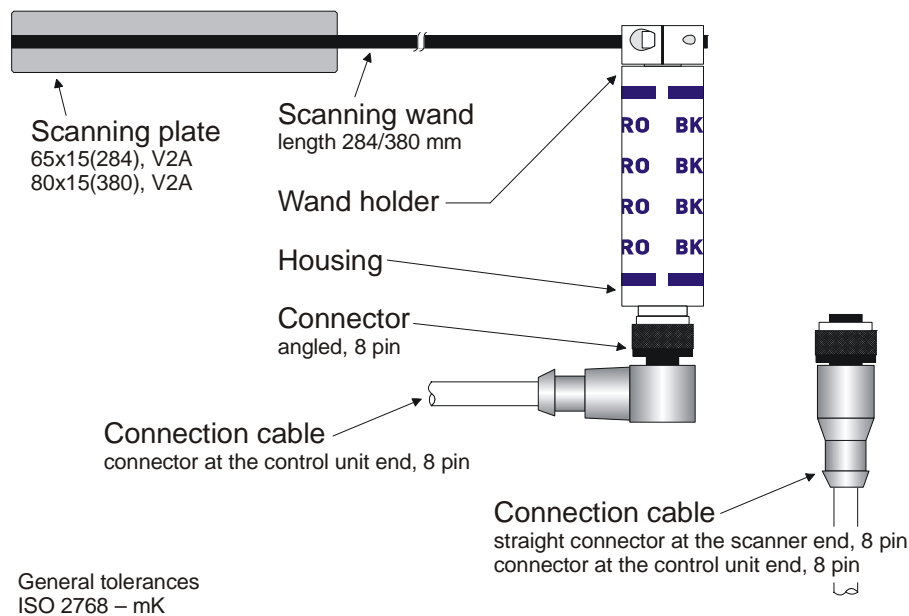

Fig. 2-14: Scanner TK8A

### 2.3.4 Scanner TK91A

- Scanning wands are available in lengths up to 610 mm  
This allows for greater distances between the scanner and tools or objects that it is checking.
- Scanning plate on the scanning wand  
This makes it possible to use the scanner directly in the tool magazine to make positive contact with the tool's tip.

The TK91A scanner has a mechanical backstop that limits the rotary movement of the wand. Using the TK91A scanner with a different control unit than the BK MIKRO9 may damage the scanner and control unit.



**Note:**

The wand is a wearing part.

**To avoid injury users should exercise caution while working in the area that the BK MIKRO wand travels.**

Example:  
TK91A with 3 balance weights

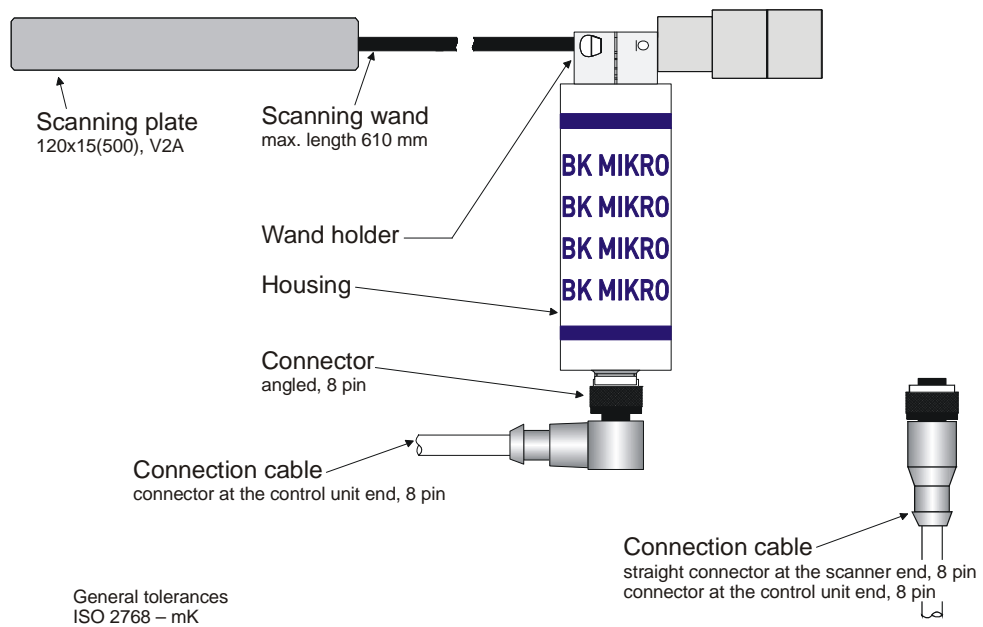

Fig. 2-15: Scanner TK91A with 3 balance weights

### 2.3.5 Balance weights for TK91A

A balancing weight may be necessary for long scanning wands that do not travel horizontally. The more balanced the wand is, the better the scanning result will be. A balance weight set (Art.-no. 62 04 282) with one small and two large weights are available for balancing.

#### Use of the balance weights for wands of different lengths

Wand length 380 mm	2 Balance weights	1 x small + 1 x large
Wand length 510 mm	3 Balance weights	1 x small + 2 x large
Wand length 610 mm	3 Balance weights	1 x small + 2 x large



**Note:**

The measuring results may vary if the wand is not traveling in a horizontal plane and balancing weights are not used. The Function of the BKM9 system in extreme installment positions and with long wands without balance weight can not be guaranteed.

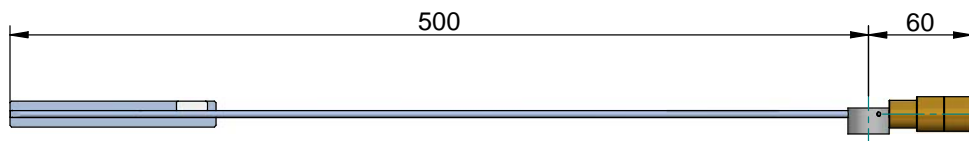

Fig. 2-16: Dimensions in mm with 3 balance weights

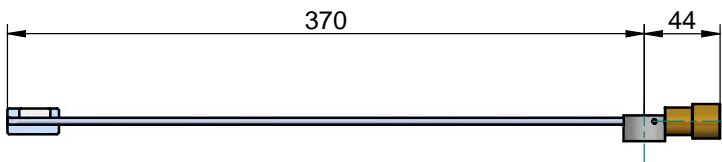

Fig. 2-17: Dimensions in mm with 2 different balance weights

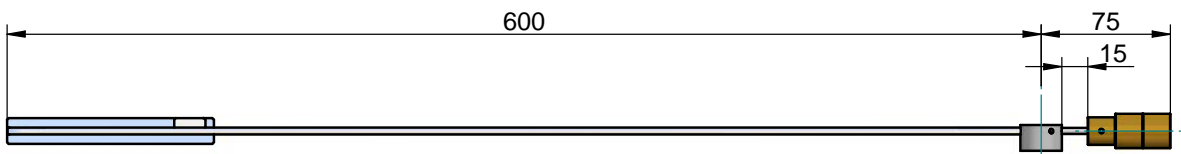

Fig. 2-18: Dimensions in mm with 3 different balance weights



**Note:**

A distance of 15 mm between wand holder and balance weights is necessary for a wand length of 610 mm!



### 2.3.6 Scanner TK94A and TK94RL

We offer two types of scanners for the different applications.

The only difference between the two scanners is that the rotary movement of TK94A wand is limited by a screw inside the housing. This screw is the mechanical backstop.

#### TK94A – Scanner with mechanical backstop

Scanner for scanning in one direction: CW or CCW

#### TK94RL – Scanner without mechanical backstop

Scanner for scanning in both directions: CW-CCW or CCW-CW, in special cases for scanning in one direction: CW or CCW



#### Note:

- Due to its small diameter the wand is easily overlooked.
- Your wand is a wearing part! Each contact with a rotating object will cause wear on the wand. That can break the wand, and the wand must be changed.
- For rotation tools an especially hardened HSS steel wand is available.

To avoid injury users should exercise caution while working in the area that the BK MIKRO wand travels.

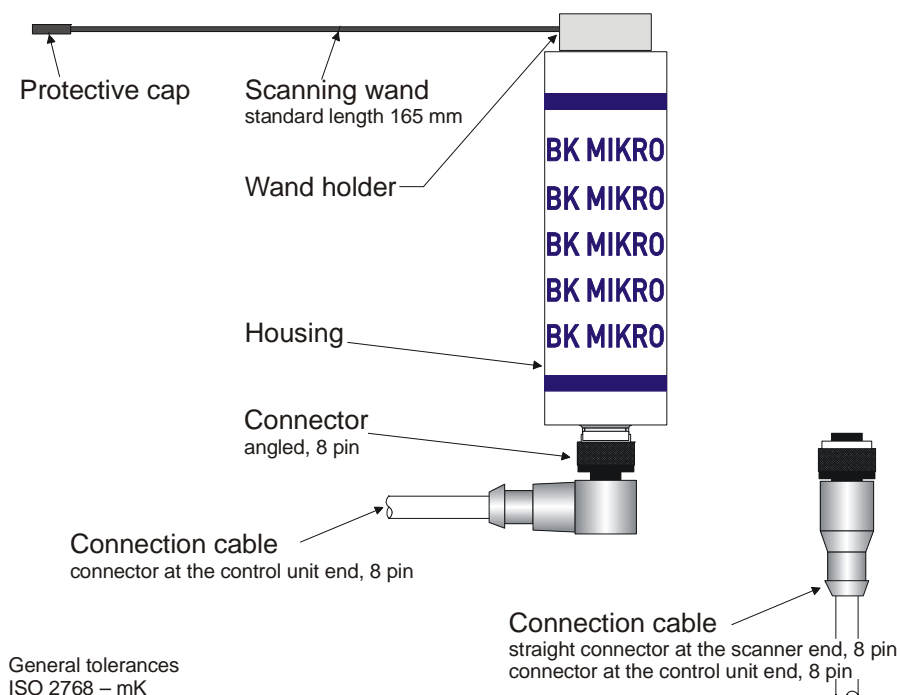

Fig. 2-19: Scanner TK94A / TK94RL



#### Note:

To prevent possible injury the wand is supplied with a protective cap.

**Option: Air barrier light connection**

To protect the s TK94A/RL scanners better against coolant and swarf, we recommend the use of the air barrier light connection. The air barrier light connection must be connected with a compressed air hose.

With overly aggressive coolant, we recommend the air barrier adapter, see chapter 2.5.

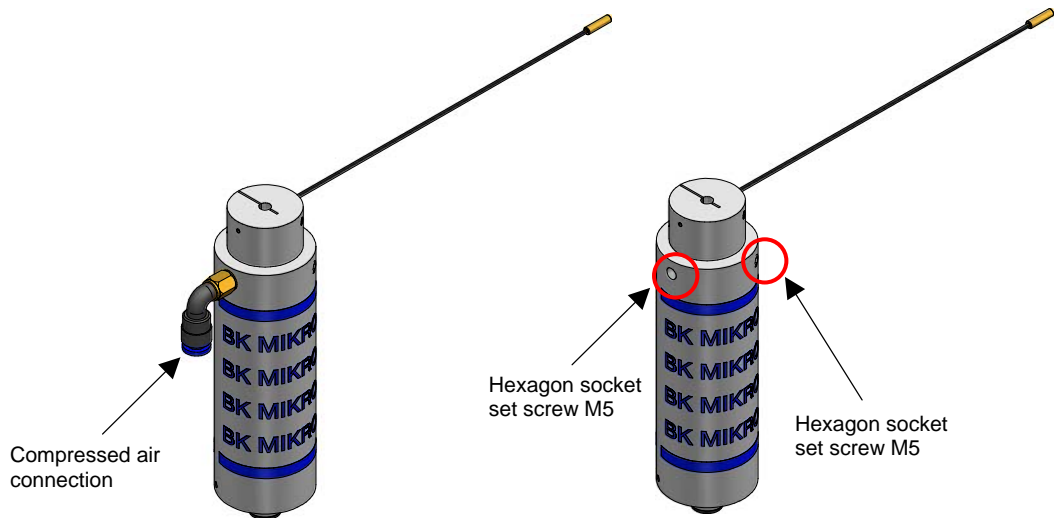

Fig. 2-20: Option: Air barrier light connection TK94A / TK94RL

Two compressed air connections for the TK94A/RL are included and can be installed if required. There are two M5 set screws that act as plugs for the compressed air connections. You must remove the plug from the hole that you plan to install the compressed air connection into. A pressure of 0.5 bars or 7.25 psi is recommended.

### 2.3.7 Scanner TK96A and TK96RL

We offer two types of scanners for the different applications.

The only difference between the two scanners is that the rotary movement of TK96A wand is limited by a screw inside the housing. This screw is the mechanical backstop.

The TK96A/RL scanner has a firmly fixed cable outlet for the connection to the control unit. This firm cable is approx. 200 mm long and can be connected onto every arbitrary control cable.

#### TK94A – Scanner with mechanical backstop

Scanner for scanning in one direction: CW or CCW

#### TK94RL – Scanner without mechanical backstop

Scanner for scanning in both directions: CW-CCW or CCW-CW, in special cases for scanning in one direction: CW or CCW



#### Note:

- Due to its small diameter the wand is easily overlooked.
- Your wand is a wearing part! Each contact with a rotating object will cause wear on the wand. That can break the wand, and the wand must be changed.
- For rotation tools an especially hardened HSS steel wand is available.

**To avoid injury users should exercise caution while working in the area that the BK MIKRO wand travels.**

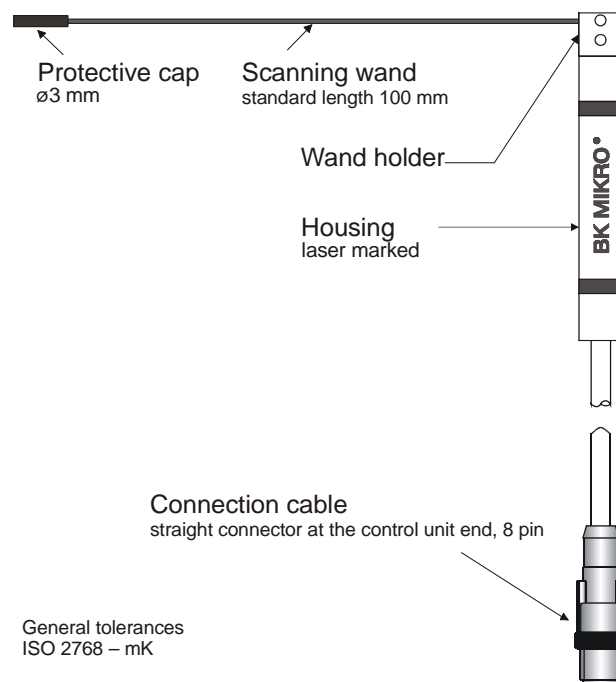

Fig. 2-21: Scanner TK96A / TK96RL



#### Note:

To prevent possible injury the wand is supplied with a protective cap.

### 2.3.8 Mounting bracket and holding arm for TK96A/TK96RL

The scanner can be fixed and attached simply with aid of the mounting bracket. The scanner is stuck by the hexagon socket set screw into the mounting bracket and then can be fixed with the drilling.

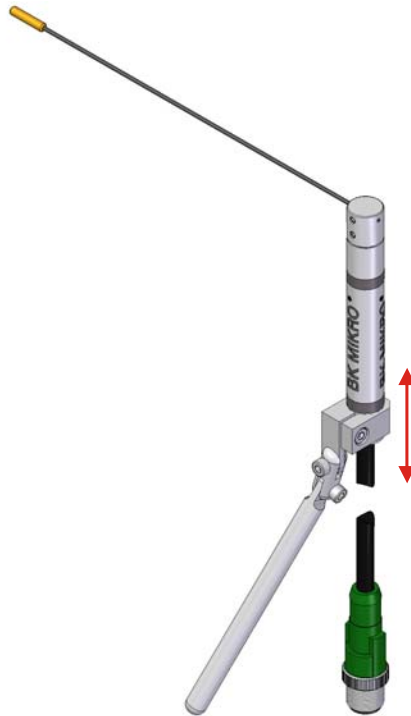

Fig. 2-22: Scanner TK96A / TK96RL

As accessories we still offer a holding arm and a knuckle joint. Instead of fixing the mounting bracket in the machine directly, the scanner can be attached also with the aid of the knuckle joint and the holding arm (see figure).



Fig. 2-23: Dimensions Mounting Bracket / Holding arm

### 2.3.9 Scanner TK9LIN50/100

The "LIN" series is designed to verify longitudinal scanning functions, where rotary scanning is unsuitable or impossible e.g. with cavities, bore holes or limited space.

Any scanning range between stop position and maximum stroke can be checked.

Two types of scanners with different strokes are available:

- TK9LIN50 with 50 mm stroke
- TK9LIN100 with 100 mm stroke

In case of use the TK9LIN50/100 scanner is measured basically instead of grade the length and unit mm.



**Note:**  
Your wand is a wearing part!

**To avoid injury users should exercise caution while working in the area that the BK MIKRO wand travels.**

Example:  
TK9LIN50

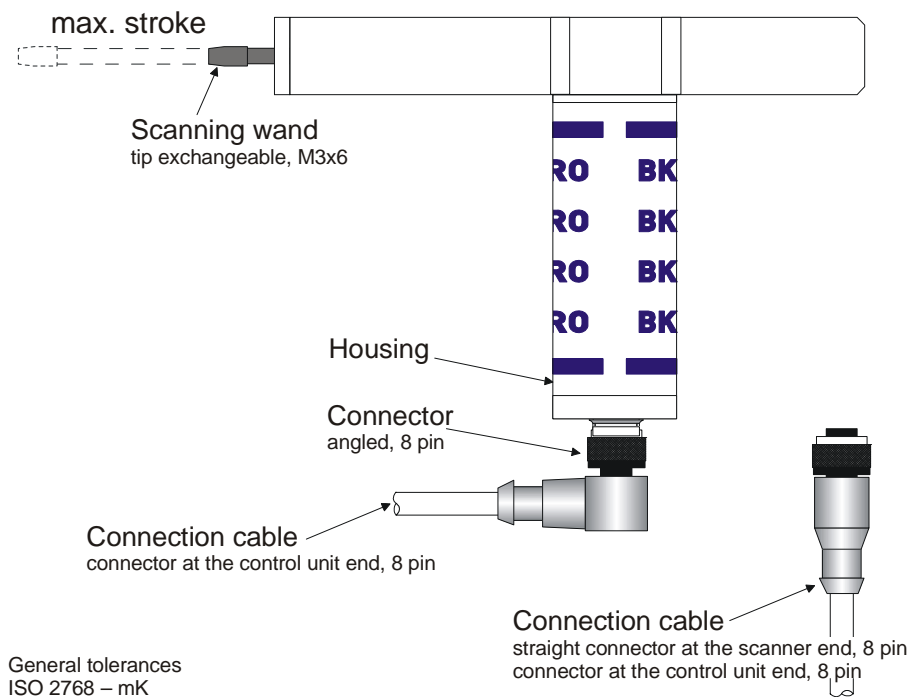

Fig. 2-24: Scanner TK9LIN50



**Note:**  
When using the TK9LIN scanner all positions are indicated in mm.  
The mm refers to the movement of the wand, e. g. ObjectPos 23.75 mm.

### Option: Compressed air balance

The TK9LIN50/100 scanners have an optional compressed air balance connection. It's possible for the rack and pinion area of the scanner to fill with liquids (coolants) over time. The compressed air balance connection allows the liquid to drain from the scanner and prevents a possible vacuum from occurring.

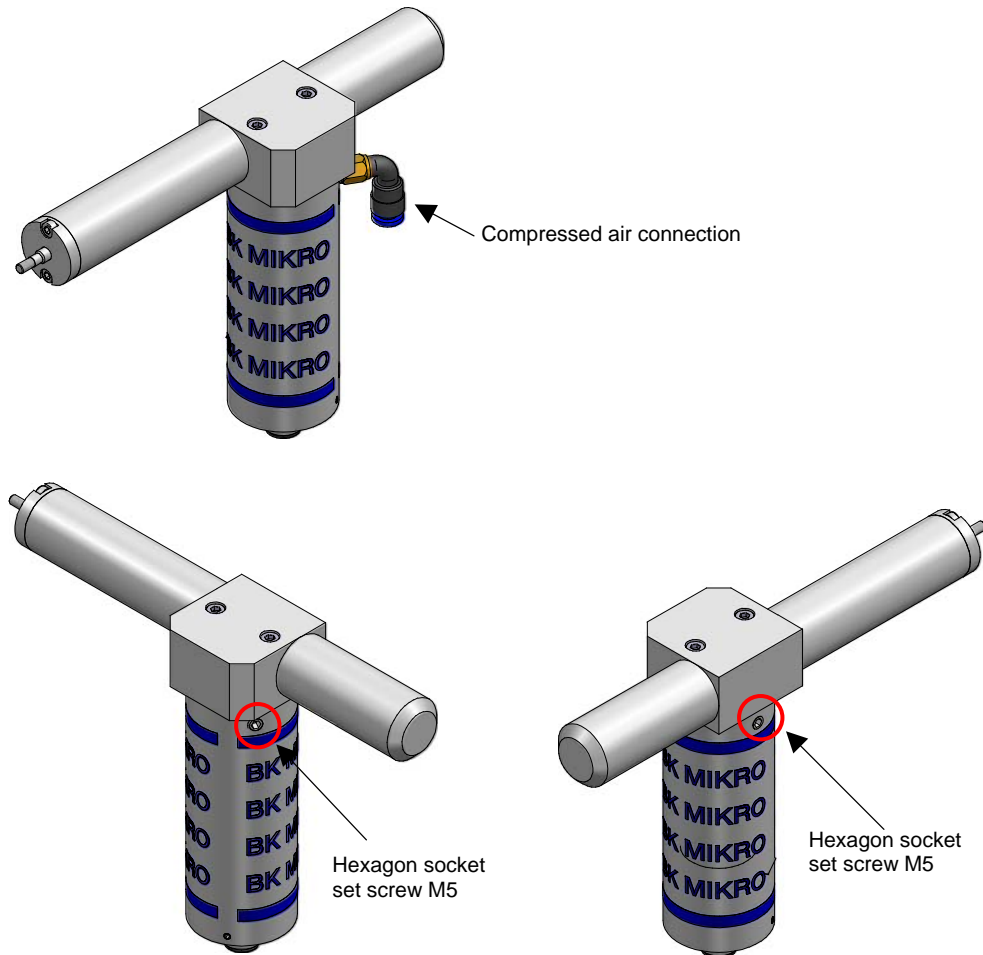

Fig. 2-25: Option: compressed air balance TK9LIN50/100

Two compressed air connections of the TK9LIN50/100 are included, which can be installed if required. In the two borings of the scanner, hexagon socket set screw M5 are inside as a protection, one of the screw must be removed before a compressed-air connection can be install. On the compressed-air connection must be applied a compressed air hose, whose end is open and stands at a protected place against liquids. With this measure can be increased the service life of the wand under liquids. The open end may not be connected on the compressed-air, its only for the pressure balance of the scanner.

## 2.4 Exchanging of the Scanning Wand

The wand can be easily removed from the wand holder by loosening the hexagon socket (M3). Insert the new wand into the wand holder and tighten.

### Notes for wand exchange

Wands of **solid material**: (Art.-no.: 6204022, 6204215, 6204216, 6204231 or similar)



These wands may be shortened or bent as required.

Wands of **hollow material**: (Art.-no.: 6204260, 6204266, 6204270 or similar)



Wands may be shortened as required. Bending is not recommended. To prevent crushing, the wand must not be hollow in the section of the scanners positioning screw.

Wands may be shortened as required. Bending is not recommended. The blind plug must be put into the end of the wand, that prevents a crimped wand.

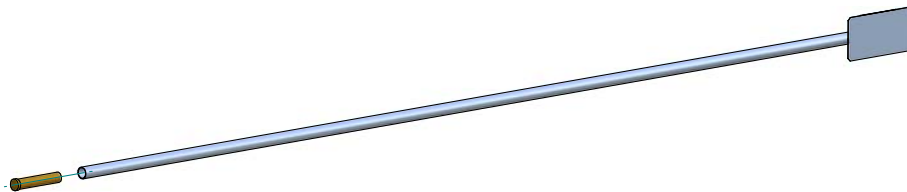

Fig. 2-26: Scanner TK91A – blind plug



#### Note:

If a hollow wand needs shortening, the provided blind plug or the pole for the balance weight set must be removed before, after this, it must be put into the open end again.

## 2.5 Air Barrier Adapter

The air barrier adapter has been mainly designed for using the BK MIKRO scanner in harsh and aggressive environments.

The adapter keeps liquids and splints away from important seals with a air barrier adapter. This leads to an increased scanner life-cycle.





### Note

Some compositions of coolants or emulsions may harm the seals, if they have an unfavorable PH value.

The gear mechanism can be damaged and internal electronics may be destroyed if liquids enter the scanner housing.

Different air barrier adapters are available for select scanners and scanning wands.

Accessories and Spare Parts	For Scanner	Article no.
BKM Air barrier adapter Axis $\varnothing=3$ mm, Wand $\varnothing=3$ mm 	TK7A/RL TK8A	62 04 027
BKM Air barrier adapter Axis $\varnothing=3$ mm, Wand $\varnothing=1.2$ mm 	TK8A	62 04 028
BKM Air barrier adapter Axis $\varnothing=4$ mm, Wand $\varnothing=1.2$ mm or 4 mm 	TK91A TK94A/RL	62 04 029

Please find the installation notes in the appropriate operation manual. (Art.-no. **68 36 266**)



## 2.6 Connection cable

Control unit and scanner are connected with a 8-wire PUR-cable:

- 8-pole molded plug on the side facing the control unit.
- 8-pole molded plug (straight or angled) facing the scanner.
- Length 5 m or 15 m, extendable up to approx. 25 m with extension cable.
- Suitable for daisy chain.



**Note:**

To increase cable life repeat movement should be kept to a minimum during operating cycles.

### 3 Operating Modes

There are three operating modes for the BK MIKRO9 system. According to system configuration the modes are available.

- Via PROFIBUS the system can be completely configured and operated.
- "Digital I/Os" with external expansion for configuration and function selection up to 512 tools.
- Additionally a mini USB-connection is available to configure and program the system without an external expansion.

#### 3.1 Operating Mode PROFIBUS-DP

##### 3.1.1 Address setting

The PROFIBUS can be set via PC with the BK Config 9 program or with help of the BKM9I/O extension module. The BK MIKRO91 control unit is delivered with an address of 50 dec.

##### Setting of the PROFIBUS address via P1 and P2

With scanner selection = 0 via P1 and P2, the profibus address can be set in connection with the BK MIKRO91 control unit. The internally memorized address in the control unit is not regarded.

Settings via P1 and P2 are hexadecimal. With P1 the rather significant bits are set and with P2 the less significant are set.

Example: Address 50 dec = 32 hex → P1 = 3, P2 = 2

##### Baud rates

Supported baud rates	
9.6	kbaud
19.2	kbaud
45.45	kbaud
93.75	kbaud
187.5	kbaud
500	kbaud
1.5	MBaud
3	MBaud
6	MBaud
12	MBaud

The baud rate is identified automatically.

### 3.1.2 General function sequence

Commands and parameter data to the BK MIKRO91 control unit are sent and received by the PLC.

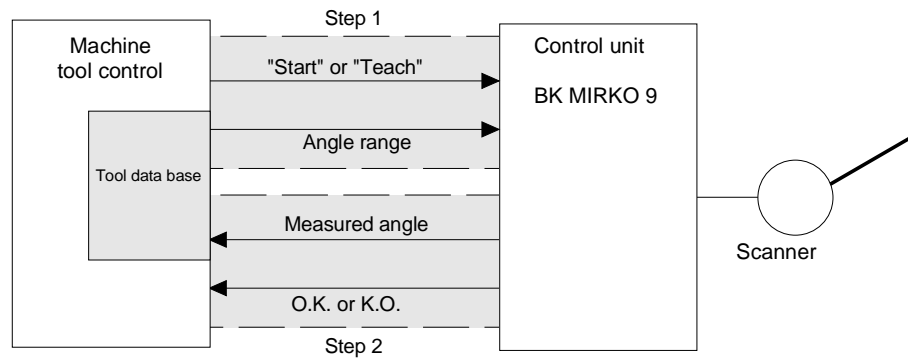

Fig. 3-1: Function sequence

The scanner moves CW or CCW (according to settings) to the zero position (= internal backstop) during power up of the control unit (ZeroPosition).

During switch-on the wand in free movement must reach the ZeroPosition, without a previous stop (caused through an object or tool)

For this operation it is necessary that the internal backstop can be reached without obstacle between wand and zero position (e.g. object or tool).

### 3.1.3 Scanning in one direction

#### Angle set value via data base

In order to check a tool (e.g. drill), the control unit receives a target angle from the machine control system via PROFIBUS. This value has been calculated according to the tool length which is filed in the tool data base. Then the measurement can begin by setting the "start" bit.

If the wand contacts an object within the correct measurement range, an OK message will be transmitted via PROFIBUS. The digital output for OK message is also switched to high or low level.

After a Teach / Start the wand goes automatically back into the HomePosition.

**Angle set value via "Teach"**

If a tool needs to be checked that doesn't have a value in the data base entry, then it is necessary to perform a "Teach" procedure. The angle set value has to be larger than the angle being taught. The angle set value serves only as an end limit for the angle range during this cycle.

If the wand contacts an object within the angle range then an OK message will be triggered and the measured angle will be transmitted via PROFIBUS to the machine control system.

This angle can be filed in the tool data base to the corresponding tool. To check the tool, the stored angle value (with tolerance) is transmitted to the control unit. Then the measurement sequence can begin by setting the bit "start".

**"Start" cycle with CW travel**

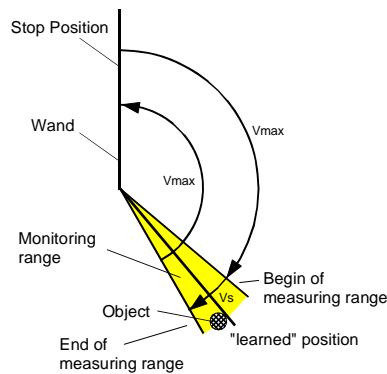

Fig. 3-2: "Start" cycle with CW travel

Monitoring range = learned (defaulted) position ± tolerance

- V<sub>max</sub> = max. speed of scanning wand
- V<sub>s</sub> = speed of scanning wand preset by "Scanning intensity"

### 3.1.4 Activation of the tool table (PC configuration software BK MIKRO9)

With the BK-Config BKM9 program different attributes and functions can be programmed for different tool numbers. Every tool has a number and is stored in the table. With the USB interface the table can be loaded into the control unit.

Normally the table is activated via the I/O from the expansion module. This is also possible via PROFIBUS.

If the "Table" bit is set in the control word AW2 then the angle set value AW3 gets it's a definition from: the tool number (Table position) stored in the controller. The "Start" bit in the control word AW2 will then execute this function from the table.

With a "Teach" bit the function is also executed and the objects new position is learned. The "GoBack", "GoPos", "Preposition" bits and the tolerance byte have no significance when the "Table" bit is active.

Using this method some functions can be used that are not possible using the Profibus, e.g. CCW/CW scanning.

### 3.1.5 Scanning in both directions (only via PROFIBUS)

A new stop position between two objects (tools) can be allocated the wand by a freely definable angle set value with the function "Go position".

No objects (tools) can be within the movement area of the wand during this process! After the wand has reached it's new stop position, the two objects can be changed and sampled. The scanning direction can be defined by the angle set value.

#### Function

When the bits "Go position" and "Start" or "Go position" and "Teach" are set simultaneously, the wand will begin with the scanning cycle.

The wand moves back to the stored new stop position after the scanning cycle. An OK or KO message will be transmitted to the machine control system simultaneously.

The direction of rotation is defined with the angle set value:

If the angle is larger than the stop position, the wand will move away from the zero position.

If the angle is smaller than the stop position, the wand will move towards the zero position.

The wand can be moved back to the zero position by setting the bit "Go Back".

Requirement: the two objects need to be removed before!

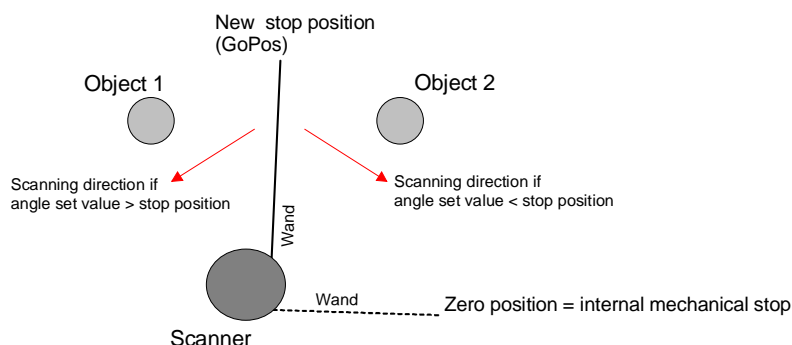

Fig. 3-3: Scanning CW / CCW



#### Note:

This function is not possible with TK9LIN50/100 scanner!

### 3.1.6 Reference travel

Using the "Reference travel" function, the scanning wand can be assigned a new HomePosition by specifying the angle of an object. In doing so, the complete measuring system is reconfigured so that the position of the object precisely matches the specified position. This function is usually used if the parameters of a measuring system have changed, e.g. after replacement of a scanning head.

#### **Sequence**

If the "Go Back" and "Teach" bits are set at the same time, the scanning wand starts the scanning process. The object found is then scanned three times in order to improve the accuracy of the measurement. A new rest position (zero position) is calculated afterwards so that an object is now located exactly in the specified position (as in the old system, e.g. before scanning head replacement).

### 3.1.7 Time-optimized scanning

The scanning time of the wand can be optimized during the outward as well as the return journey. This will result in idle time savings of the tool.

- Outward journey
  - with help of the command "Preposition"
- Return journey
  - with parameter "collision-free area" (CollFrArea) and the bit "collision-free area" (CollFrArea)
  - with parameter "time frame value" (CollChgTime) and the bit "time range" (CollChgArea)

#### Outward journey

The command "Preposition" moves the wand to the close proximity of the object to be monitored before the actual scanning procedure starts and while the tool can still be positioned.

If the tool is in the scanning position, the wand travel only a short way and through this it requires a less time.

Example: the wand is prepositioned by the command "Preposition" while the tool moves out of the tool magazine. This means that the wand moves up to 10° before the specified angle and waits at this position. Now the "Start" command initiates the scanning procedure once the tool is correctly positioned.

The advantage is the reduced travel distance of only 10° to the tool.

The command "Start" can be initiated even if the wand has not completely executed the "Preposition" command.



#### Note:

Always send a "Zero" between commands "Preposition" and "Start".

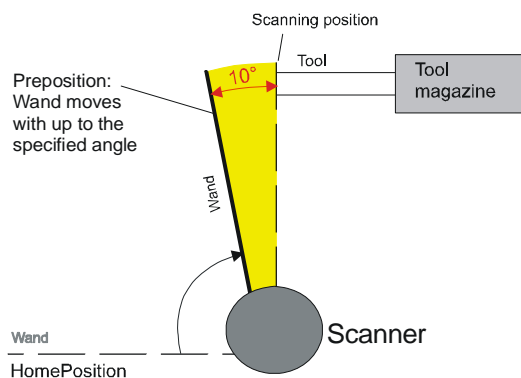

Fig. 3-4: Time-optimized scanning – Preposition

**Return travel**

The tool can be moved before the wand reaches its home-position.

- The parameter "Collision-free area" defines an area, where e.g. the largest tool not reaches, so that no collision is possible with the wand.

With the "Collision-free area" bit is specified, that the wand is in the collision-free area. As soon as this bit is set, e.g. the tool magazine, can be moved.

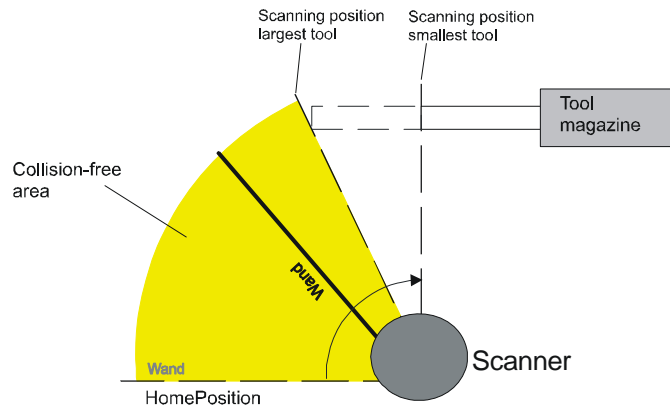

Fig. 3-5: Time-optimized scanning – "Collision-free area"

- Idle times in the system such as moving the wand toward the tool magazine can be avoided. The parameter "Time frame value" determines the required time for this procedure.

The bit "time frame" is set before the bit "collision-free area", which is determined in the parameter "time frame value".

Thus, e.g. moving towards the tool magazine can be initiated already when the wand has not arrived yet in the collision-free area. By the time the tool magazine actually moves the wand will have reached the collision-free area already.

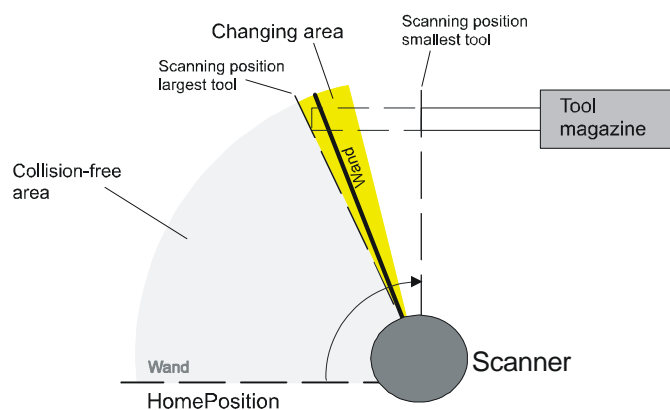

Fig. 3-6: Time-optimized scanning – "Time frame"



### 3.1.8 GSD File

The appropriate GSD file for BK MIKRO9 is named "MSCT05CF.gsd" and can be downloaded at:

<http://www.bk-mikro.com> or <http://www.techna-tool.com>

### 3.1.9 PROFIBUS DP Protocol

#### Configuration

PLC → BK MIKRO9: 3 data words output (2 bytes each)

Output words		Function
AW1	Bit 0...15	Parameter identification
AW2	Bit 0...15	Control word
AW3	Bit 0...15	Angle set value

BK MIKRO9 → PLC: 3 data words input (2 bytes each)

Input words		Function
EW1	Bit 0...15	Parameter identification
EW2	Bit 0...15	Status word
EW3	Bit 0...15	Angle

Data from PLC to BK MIKRO9 control unit will be transmitted via control words of the PROFIBUS (process channel).

Data from BK MIKRO9 control unit to PLC will be transmitted via status words.

Data transmission runs cyclically.

### 3.1.10 PROFIBUS data format

Various PLC`s interpret the byte sequence of the output and input words differently because of this. The bits 7-0 and 15-8 may get mixed up.

Like in the example below, the data is preset and transferred in the "Little Endian" format.

#### Little Endian AW 2

15	14	13	12	11	10	9	8	7	6	5	4	3	2	1	0
Tolerance								Table		PrePos	GoPos	GoBack	TEACH	START	

#### Big Endian AW 2

15	14	13	12	11	10	9	8	7	6	5	4	3	2	1	0
Table			PrePos	GoPos	GoBack	TEACH	START	Tolerance							

The particular byte sequence can be altered with help of the BK-Config BKM9 PC-program. Using this settings messages can be sent and received in either the Little Endian or the Big Endian format.

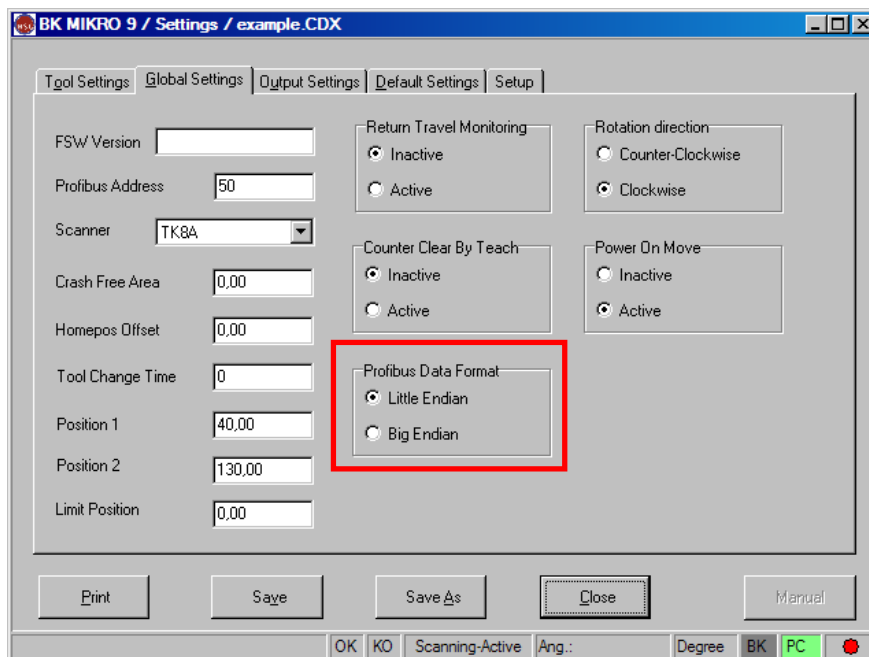

**Process data: Output words 2 and 3**

**From PLC to BK MIKRO9 control unit**

**Control word AW2**

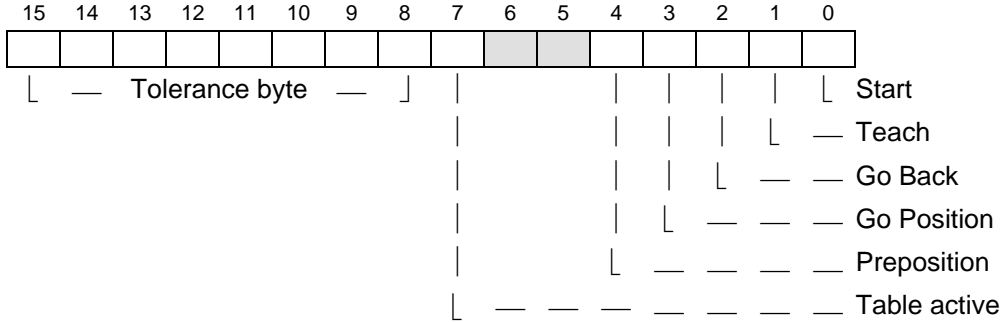

Tolerance byte	
Value	Degree [°]/mm
0	Param.
1	0.1
2	0.2
3	0.3
...	...
255	25.5

Tolerance: Specification of the angle in multiples of 0.1 degree [°]

Accept value of parameter no. 5 (Tolerance range)

**Angle set value / Length set value AW3**

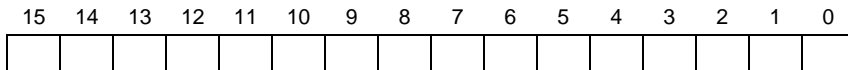

Angle set value	
Value	Degree [°]/mm
0	0
1	0.01
2	0.02
3	0.03
...	...
65535	655.35

Angle set value: Specification of the angle in multiples of 0.01 degree [°]  
(In the mode "mm", the tool size is specified in mm.)

Angle min.    8°:    320 hex    =    0000 0011 0010 0000  
 Angle max.    300°:    7530 hex    =    0111 0101 0011 0000

Angle specification	
Value	Degree [°]
0	0°
1	0.01°
2	0.02°
3	0.03°
...	...
65535	655.35°

Angle specification: Indicates the angle in multiples of 0.01 degree [°]

Min. Angle    8°:    320 hex    =    0000 0011 0010 0000  
 Max. Angle    300°:    7530 hex    =    0111 0101 0011 0000

**Status words: Input words 2 and 3**

**From BK MIKRO9 control unit to PLC**

**Status word EW2**

15	14	13	12	11	10	9	8	7	6	5	4	3	2	1	0		
█	█	█	█	█	█	█	█	█	█	█	█	█	█	█	█		
																└	Wand in stop position
																└	Scanning active
																└	OK
																└	KO
																	Scanning area not reached
																	Time frame (CollChgArea)
																	Collision-free area (CollFrArea)
																	Error: Cable break
																	Error: Scanner
																	Error: Control unit
																	Error: Wand
																	Error: Angle set value
																	Error: Control word
																	Error: Parameter

**Angle / Length EW3**

15	14	13	12	11	10	9	8	7	6	5	4	3	2	1	0
█	█	█	█	█	█	█	█	█	█	█	█	█	█	█	█

Angle	
Value	Degree [°]/mm
0	0
1	0.01
2	0.02
3	0.03
...	...
65535	655.35

Angle: Specification of the angle in multiples of 0.01 degree [°]  
 (In the mode "mm", the tool size is specified in mm.)

**Parameter**

The transmission of the parameters also run cyclically via the process channel of the PROFIBUS.

**From PLC to BK MIKRO9 control unit**

**Parameter identification AW1**

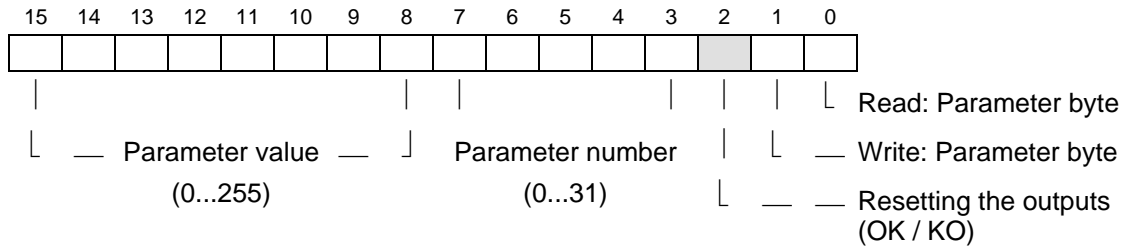

**From BK MIKRO9 control unit to PLC**

**Parameter identification EW1**

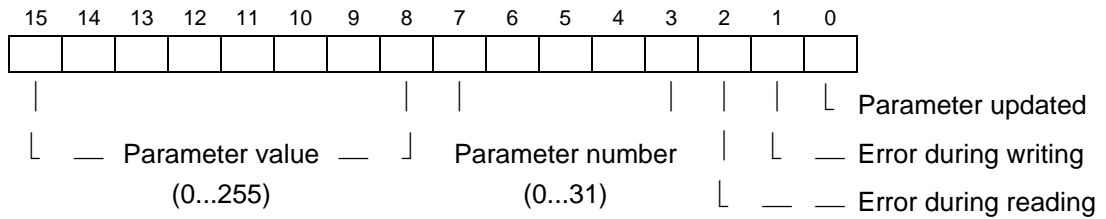

## Parameter list

Number	Name	Default	Min.	Max.	Format	Description
0	Scanning intensity	0	0	7	Dec	<b>0 = Low</b> 1 = High 2 = Intermediate level 1 3 = Intermediate level 2 4 = Intermediate level 3 5 = Intermediate level 4 6 = Intermediate level 5 7 = Intermediate level 6
1	Special functions Out1	0000 001	0	255		See declaration of the parameters
2	Out2 Relay output	1	0	1	Boolean	0 = InActive normally open <b>1 = Active normally closed</b>
3	Monitoring	1	0	7	Dec	0 = Free space <b>1 = Object</b> 2 = GoPos 3 = GoBack 4 = TK91A610 5 = TK91A510 6 = Object (both sides) 7 = Free space (both sides) 8 = TK96A/RL 9 = TK91A732 128 = User Tastkopf 1 129 = User Tastkopf 2
4	Rotation direction	1	0	1	Bool	0 = Left <b>1 = Right</b>
5	Tolerance range	300	2	255	0.1°/mm unit (PB) 0.01°/mm unit (USB)	<b>3.00°/mm</b> (Default)
6	Scanner	0	1	129	Dec	<b>0 = AutoDetect</b> 1 = TK8A 2 = TK7A 3 = TK8A Short Wand 4 = TK9A 5 = TK9A Fast long 6 = TK94A/RL 7 = TK9LIN50/100 8 = TK Reserved 1 9 = TK Reserved 2 10 = TK Reserved 3 128 = User Scanner 1 129 = User Scanner 2
7	P1 Low byte	160	0	255	0.01°/mm unit	Position 1
8	P1 High byte	15	0	255	2.56°/mm unit	<b>40.00°/mm</b> (Default)
9	P2 Low byte	200	0	255	0.01°/mm unit	Position 2
10	P2 High byte	50	0	255	2.56°/mm unit	<b>130.00°/mm</b> (Default)
11	Return travel monitoring	0	0	1	Boolean	<b>0 = Outputs do not change.</b> 1 = If wand does not come back during return travel, KO output will be active.
12	Power On	1	0	1	Boolean	0 = Wand will not travel after Power On. <b>1 = Wand will travel to stop position after Power On.</b>
13	Output setting	0	0	1	Boolean	<b>0 = Outputs will set at the object position</b> 1 = Outputs will set at the Home-Position
14	Output back setting	0	0	1	Boolean	<b>0 = Outputs will set back at the next scanning.</b> 1 = Outputs will set back with a fallen "Start"-Signal.
15	HomePos offset	0	1	255	°/ unit	0 = Inactive 1..255
16	Reserved	-	-	-	-	-
17	Common options	0	0	255	Bool	See appendix
18	Home-position-Offset	0	0	255	0.1°/mm unit (PB) 0.01°/mm unit (USB)	<b>0.00°/mm</b> (Default – adopt scanner parameter)

19	Time frame value	0	0	255	1ms unit	<b>0ms</b> (Default – tool replacement area = tool free-space)
20	Collision-free area	0	0	255	1°/mm unit (PB) 0.01°/mm unit (USB)	<b>0.00°/mm</b> (Default – adopt scanner parameter)
21	Monitoring unit	0	0	1	Boolean	<b>0 = Grad</b> 1 = Millimeter
22	Distance Low byte	0	0	255	0.01mm unit	<b>0.00mm</b> (Default)
23	Distance High byte	0	0	255	2.56mm unit	
24	Reference angle Low byte	0	0	255	0.01° unit	<b>0.00°</b> (Default)
25	Reference angle High byte	0	0	255	2.56° unit	
26	Tool length Low byte	0	0	255	0.01mm unit	<b>0.00mm</b> (Default)
27	Tool length High byte	0	0	255	2.56mm unit	
28	BKM variant	Read_only			Hex	10h = Basic93 20h = Premium91 21h = Premium92 22h = Premium91I
28	BKM variant	Read_only			Hex	10h = Basic <b>20h = Premium</b>
29	Date month	Read_only			Dec	Date month
30	Date year	Read_only			Dec	Date year
31	FW version	Read_only			Dec	Software version

**Declarations concerning parameters**

The table shows the allocation of parameters 0 ... 31.

There are parameters that can be read as well as to. Other parameter are "read\_only".

An attempt to write a read\_only parameter causes an error message.

0. Scanning intensity  
 Scanning intensity determines the size of strength and rate during the learning cycle and/or within the tolerance range of start cycle. There are 8 steps of setting.

1. Special functions  
 The 8 bit data word of this parameter get partitioned in a 4 bit sub address and a 4 bit data word.

15	14	13	12	11	10	9	8
Sub-Address				Data			

Sub-Address	Data
0000	Out 1 0000 inactiv 0001 activ
0001	Scanning Mode (downtime characteristics) 0000 normal 0001 Vibration tolerant 0010 Fast
0010	PrePosition Speed 0000 standart (fast, large ringing) 0001 very slow (at slowlyest, low ringing) 0010 slow

**Out1**

With this parameter can define the active status of the relay output 1. After switch-on the outputs the adjusted status "Open" or "Close" is set, without a scanning before.

**Scanning Mode**

Normal – The scanning wand must be stopped to finish the measurement.

Vibration Tolerant – If vibrations are behaviour in the machine, it requires a longer time that BK MIKRO diagnosed the stop of the scanning wand. In this mode small actions are tolerated. The result of measurement will be non-essential affected.

Fast – In this mode the measurement will be stopped after arriving the object. With this fast mode it is possible to recognize if the object is in the specified tolerance. Due to the reduced measuring time the result of measurement will be more inaccurate.

**PrePosition Speed**

The speed of the PrePosition can be changed. PrePosition verändert werden. This has an influence how fast the position of the PrePos will be achieved and how strong the wand swings.



2. **Out2**  
Using these parameters, the relay output 1, relay output 2 can be defined as to how they should behave in the "active" condition.  
  
After switch-on the control unit these outputs are always either in the set state "normally closed" or "normally open" even before a scanning cycle has occurred.
3. **Monitoring**  
Using this parameter, either object or free space monitoring can be specified.  
Object monitoring: When an object is scanned the OK output is active if the presence of the object is detected in the specified range. The KO output is active if the object is not present.  
Free space monitoring – checks, if the specified area can be exceeded without hit to a barrier  
The ranges are specified using either the angle and tolerance definitions or using the P1 and P2 position parameters. If the angle is defined as 0, then P1 and P2 are used as the tolerance range.  
"Tolerance range" is used as the +/- tolerance range if 0 is input for the tolerance here. The wand will travel to a specified position (GO Position) for the positioning run. This is specified by the object position.  
"Go Back", the wand travels in a specified direction until it encounters an obstacle (normally this is the internal end stop). The HomePosition is defined and set at this position.  
Touch – the wand presses for so long against an object until the check is stopped. The current position of the wand is monitored in doing so. Outputs for "warnings" and "errors" ranges are then set or reset corresponding to the wand position. It can be established from this monitoring, e.g. whether a scanned product is the 1st, 2nd or 3rd choice.  
In the case of scanning on both sides, objects or free spaces can be monitored in both directions (with respect to the starting position).
4. **Rotation direction**  
This parameter changes the scanning direction of the wand.  
As soon as the parameter is changed, the wand travels in the other way to the internal stop.
5. **Tolerance range**  
This parameter sets the tolerance range. With this information the tolerance range has not to be set in start cycle.  
  
Tolerance range = 0 in control word: +/- parameter value is used as tolerance range.

6. Scanner  
Settings of the scanner (for further applications).

Scanning wand parameter Meaning:

Wert	Type	Bemerkung
0	TK_AutoDetect	Activate of the automatically detection from the scanner wands. Only for scanner wands TK9xxx. Ist der Tastkopf TK91A angeschlossen wird Parametersatz 5 geladen.
1	TK8A	Scanner wand TK8A standard-needle 380mm
2	TK7A/RL	Scanner wand TK7A/RL standard-needle 165mm
3	TK8A Short Wand	Scanner wand TK8A short needle 165mm (low intensity)
4	TK91A610	Scanner wand TK91 optimised up to 610mm needle.
5	TK91A510	Scanner wand TK91A standard-needle up to 610mm, fast action, time saving (optimised for 510mm needle)
6	TK94A/RL	Scanner wand TK94A/RL standard-needle 165mm
7	TK9LIN	Scanner wand TK9LIN
8	TK96A/RL	Scanner wand TK96A/RL standard-needle 100mm
9	TK91A732	Scanner wand TK91 optimised up to 732mm needle
128	USER_0_NotDef	Special detected parameter for one scanner wand. Loadable in the menu File-Scanner. If this programmable appear instead of "NotDef" the assigned scanner wand name.
129	USER_1_NotDef	Special detected parameter for one scanning wand. Loadable in the menu File-Scanner. If this programmable appear instead of "NotDef" the assigned scanner wand name.



**Note:**

In case of a change of the scanner parameters the system must be restarted, the new wand parameters will be are taken over!

- 7./8. Position 1: P1 Low byte, P1 High byte and  
 9./10. Position 2: P2 Low byte, P2 High byte

Using these parameters the angle set value can be preset by P1 and P2.  
 These values are used as range set value as soon as angle set value = 0.

11. Return travel monitoring  
 Using this parameter the OK output can be activated in case of non-attaining the stop position. If return travel monitoring is not active, this information can also be interrogated in bit "Wand in stop position" via PROFIBUS.
12. Power On  
 Using this parameter it can be prevented that the wand starts moving immediately after switch-on of the power supply.  
  
 Usually set parameter to 0: Default!
13. Setting outputs  
 The outputs are switching if the wand hits the object or first if the wand occurs the HomePosition.
14. Resetting outputs  
 The outputs can be reset either with the next scan or with the falling "Start" signal.
17. Parameter index  
 Bit 0: Scanning mode A or R/L  
 Bit 1: Scanner powerless

#### **Common Options**

- Bit 0 Scanning mode  
 Inaktiv: The scanner scans only in one direction an object.  
 Aktiv: A function R/L is generated for the tool table.  
 In this mode a table-bit (AW2 bit 7) must be active at TEACH or START. At TEACH both positions will be stored in an tool table. At START both tool will be scanned.
- Bit 1 Inaktiv: Scanner controls the position (normal operation).  
 Aktiv: The scanner motor will be powerless. The wand can be travel freely.  
 At power-on, this bit will be deleted and the scanner travels normal.

18. HomePosition  
 The "HomePosition" of the wand before of the mechanical backstop can be adjusted between 0.1° and 25.5°.  
 The standard value of the particular scanner will be use if it is "0", e.g.8°.

- 19. Time frame value  
This value determines when the bit "time frame1" will be set (before the bit "collision-free area").
- 20. Collision-free area  
Here the "Collision-free area" of the wand is defined (e.g. outside a tool magazine).
- 21. Monitoring unit  
All objects and free spaces can be monitored in two different ways:
  - in degree units: all information is in degrees [°]
  - in millimeter units: all information is in millimeters [mm]



**Note:**

In order to use the millimeter mode the following three parameters must be configured as a reference for the millimeter conversion: Distance, Reference angle and Tool length.

22./23. Distance

This parameter corresponds to the distance between the scanner axis and the tool, which the scanner wand would contacted at 90°.

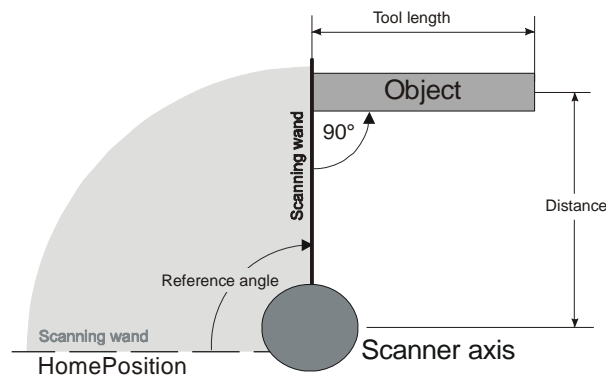

Fig. 3-7: Distance



**Note:**

In order to use the millimeter mode, the following three parameters must be configured as reference for millimeter conversion: Distance, Reference angle and Tool length.



**Note:**

This function is not possible with TK9LIN50/100 scanner!

**24./25. Reference angle**

This parameter corresponds to the angle between the tool and the rest position at the 90° position of the tool to the wand.

**Note:**

In order to use the millimeter mode, the following three parameters must be configured as reference for millimeter conversion: Distance, Reference angle and Tool length.

**26./27. Tool length**

This parameter corresponds to the tool length at the 90° position of the tool to the wand.

**Note:**

In order to use the millimeter mode, the following three parameters must be configured as reference for millimeter conversion: Distance, Reference angle and Tool length.

### 3.2 Operating Mode Digital I/O

The wand moves to home-position when the control unit is turned on. This means the wand rotates to the left or right until it reaches the internal backstop, depending on the preset parameters.

That's why there is to provide, that the wand can move freely into home-position without previous stop at an object or tool.

#### "Teach" cycle

When a pulse to the "Teach" input is turned on, the wand will begin with the scanning cycle. The wand rotates until it contacts on an object or tool. This position will be stored in the control unit's internal data base. The number of the tool is defined by the selected teach input.

The default values for tolerance and scanning intensity can be adjusted using the configuration software or with the DIP switches.

Whether the wand has not contacted any object during the "Teach" cycle, it moves to the angle which is above of the "Teach" position and "Tolerance" parameter, returns and sets the "KO" message.

#### "Start" cycle with CW travel

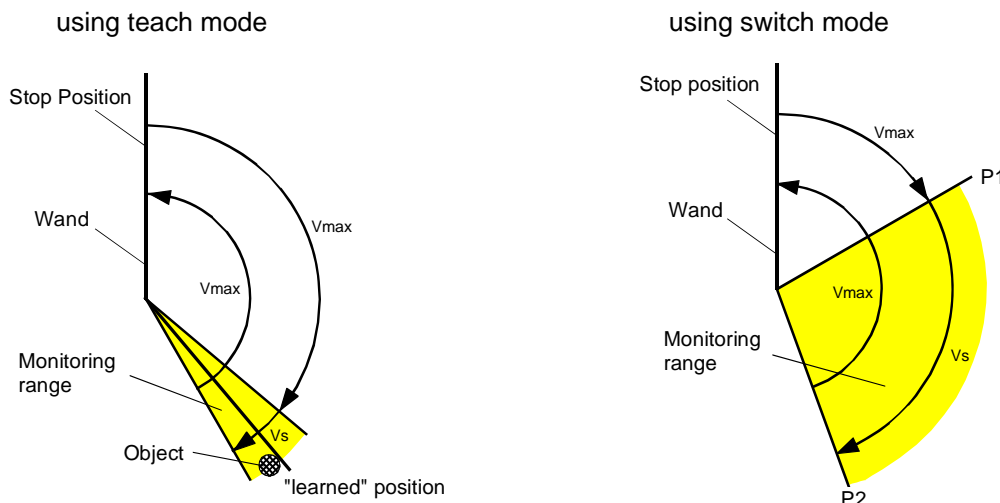

Fig. 3-8: "Start" cycle with scanning in both directions

Monitoring range = Range of tolerance for "OK" message

- Vmax = max. speed of scanner
- Vs = speed of scanner preset by "Scanning intensity" toggle switch

The tool number that you would like to check needs to be selected with the correct binary pattern, then the "start" impulse is applied. The wand will then begin the scanning process.

If the wand contacts the object at the learned position, an "OK" message will be set. If the wand is stopped before the monitoring range or exceeds the area then a "KO" message will be set.

The wand rotates at a higher speed and slows down to scan the monitoring range with reduced speed and strength.

During the scanning process, i.e. after a "Start" pulse the wand will initially travel at maximum speed to the start of a given monitoring range. The motor will slow down to a preselected scanning speed in time before reaching the learned position or a preselected angle which is set by the rotary switches is reached.

The wand travels through the area to be monitored and the scanning occurs with the set intensity.

If the system detects that the scanner no longer moves or has exceeded the end of the monitoring range, the direction of rotation immediately changes, and the scanner will return at maximum speed to its stop position.

Depending on the result of scanning the corresponding relay will be activated, and the corresponding LED will indicate the result at the control unit.

### 3.2.1 Switch mode = monitoring scanning range with switch settings

**Requirement: Rotary switches  $0 \leq P1 < P2 \leq 270$**

Rotary switch P1 and P2 settings will define the scanning range.

In this mode of operation, the BK MIKRO is capable of **monitoring tools** with different diameters (object monitoring) as well as for **ejection monitoring** (free space monitoring):

The two rotary switches are used to define a scanning range which is monitored during each cycle.

P1 defines the starting angle and P2 defines the ending angle of a scanning range. During the object monitoring an "OK" will be transmitted, if the wand contacts an object within the scanning range.

### 3.2.2 Control operation "Object monitoring"

Using "Object monitoring", the control unit will change into an "OK" signal, i.e. it will issue a good message, if during the scanning cycle the operation sequence described below is followed:

- The scanner leaves its stop position.
- The angle preset via rotary switch P1 has been exceeded.
- The angle preset via rotary switch P2 has not been reached.

### 3.2.3 Control operation "Free space monitoring"

The operation of "Free space monitoring" differs from object monitoring mode in that within its monitoring range no object must be detected.

Its "OK" state is characterized by:

- The scanner leaves its stop position.
- The angle preset via rotary switch P2 has been exceeded.



**Caution:**

When performing "Free space monitoring", a **broken wand** will always trigger an **"OK" signal**.

### 3.2.4 Output of results

- Fault message (KO)

A fault message is immediately outputted upon detection.  
The scanner travels back to the stop position.

- Good cycle message (OK)

– The good cycle message is outputted immediately after recognition (on the object).  
Results will be indicated once the wand reaches its stop position.

These are the standard settings. With the aid of the BK-Config PC program you can set further parameters for the outputs. Parameters as "Return travel monitoring" and "Time of the switching" (Object / HomePosition) can be set.



### 3.3 Function Mini-USB

#### Configuration program for BK MIKRO9

It is possible to control and make parameter changes to the BK MIKRO9 control unit via USB-interface of a host-PC with the help of the configuration program "System Setup BK MIKRO9".

After starting the configuration program, the start-page will appear where various functions can be selected in the menu.

Up to 512 functional attributes like specified angle, tolerance and dead stop power can be defined in the programming operation.

The present monitoring cycle status is displayed detail when in manual mode.

The wand can be operated or set manually (=>Manual Mode). A trace function for long-term monitoring is available (=>Trace ).

For further information's please use the help menu of the program.

The program is free to download at:

<http://www.bk-mikro.com/de/>

## 4 Technical Data

### 4.1 Control Unit

Housing	Insulating material housing, protection class II, built-in unit
Protection type	IP 20
Dimensions (W x H x D)	22.6 mm x 99 mm x 113.6 mm
Case mountings	Sectional rail, 35 mm, to DIN EN 50022
Power supply voltage	24 VDC $\pm 20\%$ SELV <sup>1)</sup> $I_{max} = 1 A$
Power consumption	24 VA max.
Control voltage	24 VDC $\pm 20\%$ SELV <sup>1)</sup>
Inputs - Input current - Pulse duration	Galvanically isolated 5 mA approx. 30 ms min.
Switched outputs	2 x 30 VDC, 1 A max.
Operational life of relay	5x10 <sup>5</sup> switching cycles (depending on switching current)
Connections	Plug-in screw terminals for connecting - power supply, relay outputs, control inputs Scanner, small circular socket, 8 pin Mini-USB PROFIBUS, Sub-D socket, 9 pin, (only BKM91 Premium)
Climatological conditions	Classification 3K3 under EN 50178
Ambient temperature	0 °C to +50 °C
Storage temperature	-25 °C to +80 °C

<sup>1)</sup> The voltage applied must meet the requirements for the safety-low voltage (SELV) according to EN 60950. DC Power input LV (Limited Voltage) and LC (Limited Current) according to UL 508. Protection approved according to UL248 with a maximum of 4A should be used between the voltage supply and the BK MIKRO9 control unit.

### Mechanical Dimensions

- Mechanical Dimensions are considered for all control units BK MIKRO9.

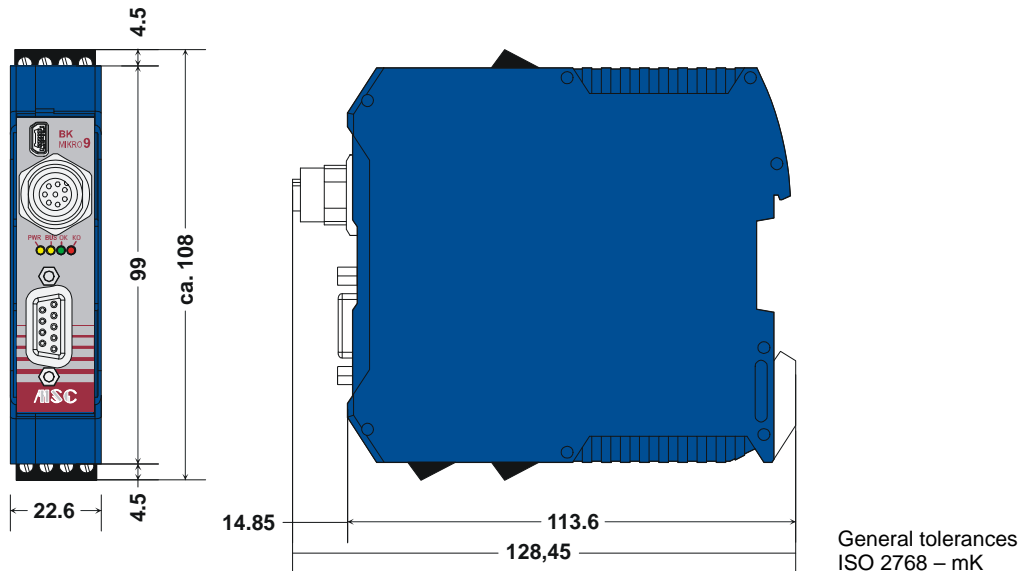

Fig. 4-1: Mechanical Dimensions – Control Unit BK MIKRO9

## 4.2 I/O Expansion Module

Housing	Insulating material housing, protection class II, built-in unit
Protection type	IP 20
Dimensions (W x H x D)	22.6 mm x 99 mm x 113.6 mm
Power supply voltage	24 VDC $\pm 20\%$ SELV <sup>1)</sup>
Inputs – Input current – Pulse duration	Galvanically isolated 5 mA approx. 30 ms min.
Switched outputs	2 High side switch with maximum output current 0.5 A
Connections	Plug-in screw terminals for connecting – 10 Inputs, 2 Outputs (with power supply voltage)
Climatological conditions	Classification 3K3 under EN 50178
Ambient temperature	0 °C to +50 °C
Storage temperature	–25 °C to +80 °C

<sup>1)</sup> The voltage applied must meet the requirements for the safety-low voltage (SELV) according to EN 60950. DC Power input LV (Limited Voltage) and LC (Limited Current) according to UL 508. Protection approved according to UL248 with a maximum of 4A should be used between the voltage supply and the BK MIKRO9 control unit.

### Mechanical Dimensions

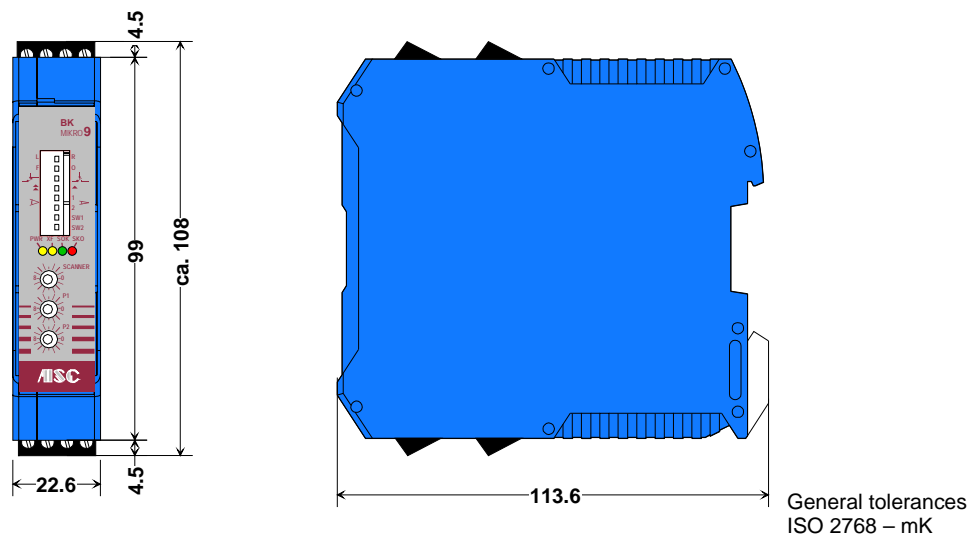

Fig. 4-2: Mechanical Dimensions – I/O Expansion Module

**4.3 Scanner TK7A and TK7RL**

Housing	Anodized aluminum
Protection type	IP 67
Scanning wand length	250 mm (standard), Ø: 1.2 mm, scanning wand exchangeable
Scanning angle – TK7A – TK7RL	max. 270° (-A) max. 360° (-RL)
Control unit connection	Small circular connector, M12x1, 8 pin
Ambient temperature	0 °C to +80 °C
Storage temperature	-25 °C to +85 °C
Scanning cycles	> 5 million at minimum scanning intensity

**Mechanical Dimensions**

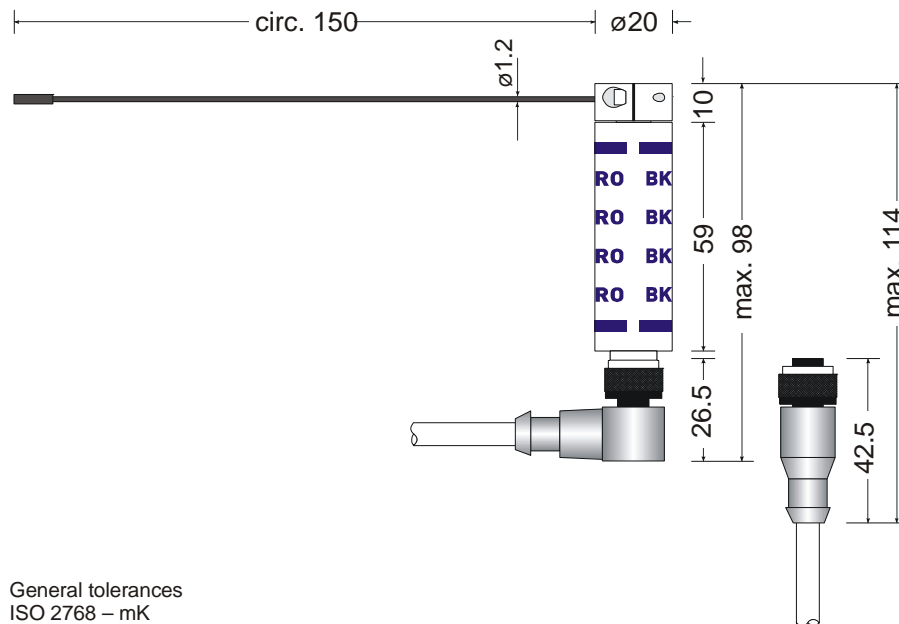

Fig. 4-3: Mechanical Dimensions – Scanner TK7A / TK7RL

**4.4 Scanner TK8A**

Housing	Anodized aluminum
Protection type	IP 67
Scanning wand length	380 mm, with plate 80 mm x 15 mm, 284 mm, with plate 65 mm x 15 mm, wand exchangeable
Scanning angle	300° max. (with backstop)
Control unit connection	Small circular connector, M12x1, 8 pin
Ambient temperature	0 °C to +80 °C
Storage temperature	-25 °C to +85 °C
Scanning cycles	> 5 million at minimum scanning intensity

**Mechanical Dimensions**

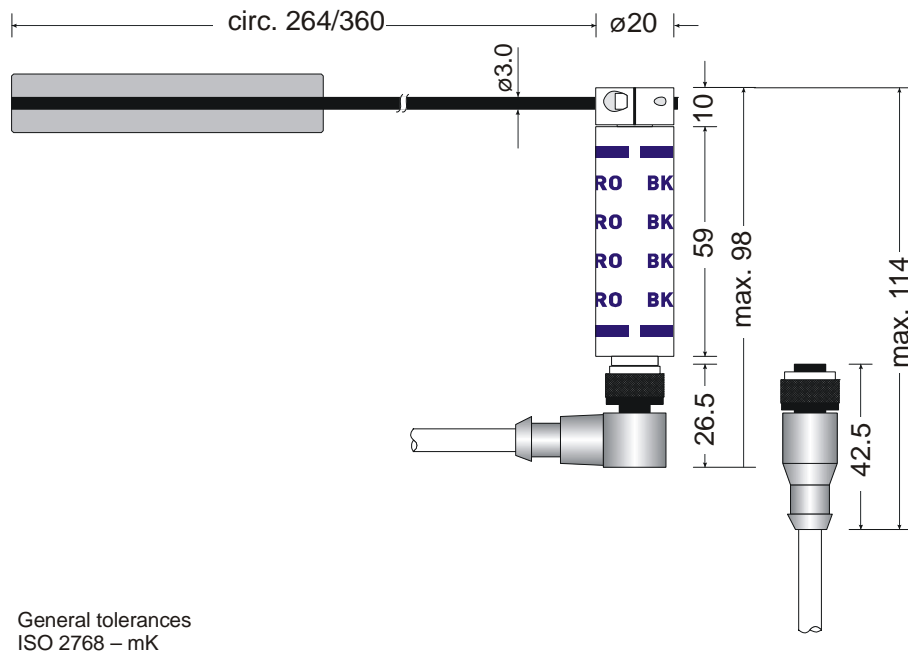

Fig. 4-4: Mechanical Dimensions – Scanner TK8A

### 4.5 Scanner TK91A

Housing	Anodized aluminum
Protection type	IP 67
Scanning wand length	Up to 610 mm max., with plate 120 mm x 15 mm
Scanning angle	300° max. (-A)
Control unit connection	Small circular connector, M12x1, 8 pin
Ambient temperature	0 °C to +80 °C
Storage temperature	-25 °C to +85 °C
Scanning cycles	> 5 million at minimum scanning intensity

### Mechanical Dimensions

For example:  
TK91A with 510 mm scanning wand length and 3 balance weights

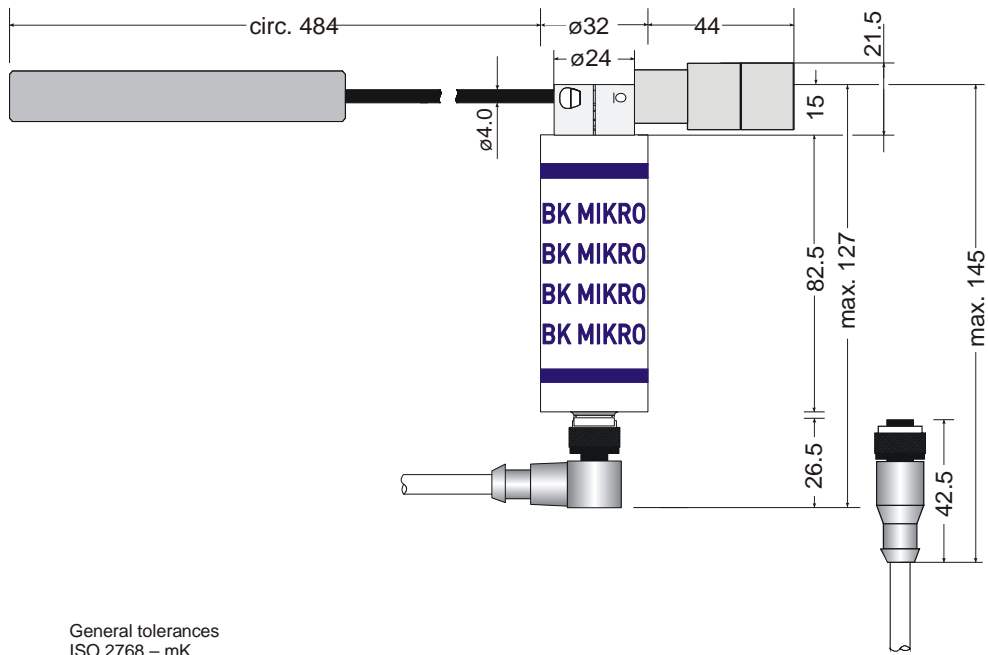

Fig. 4-5: Mechanical Dimensions – Scanner TK91A

4.6 Scanner TK94A

Housing	Anodized aluminum
Protection type	IP 67
Scanning wand length	165 mm (standard), $\varnothing$ : 1.2mm, scanning wand exchangeable
Scanning angle	300° max. (-A)
Control unit connection	Small circular connector, M12x1, 8 pin
Ambient temperature	0 °C to +80 °C
Storage temperature	-25 °C to +85 °C
Scanning cycles	> 5 million at minimum scanning intensity

Mechanical Dimensions

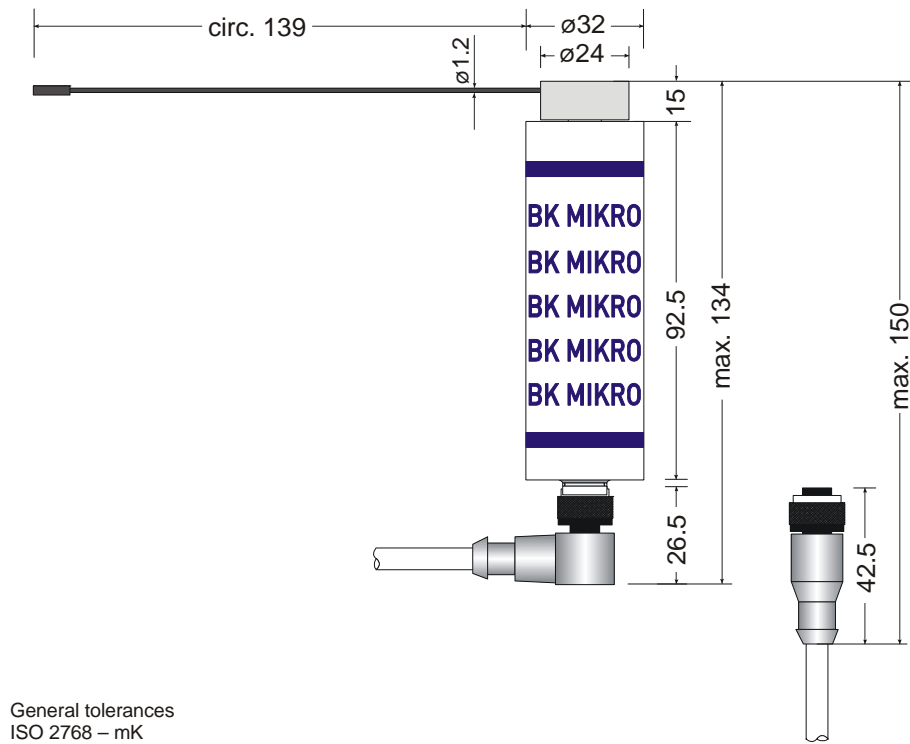

Fig. 4-6: Mechanical Dimensions – Scanner TK94A

Option: air barrier light adapter



Fig. 4-7: Mechanical Dimensions – Option Air barrier light adapter

**4.7 Scanner TK96A and TK96RL**

Housing	Stainless steel
Protection type	IP 67
Scanning wand length	100 mm (standard), $\varnothing$ : 1.2 mm, scanning wand exchangeable
Scanning angle – TK7A – TK7RL	max. 270° (-A) max. 360° (-RL)
Control unit connection	Fixed cable (200 mm) with Small circular connector, M12x1, 8 pin
Ambient temperature	0 °C to +65 °C
Storage temperature	-25 °C to +80 °C
Scanning cycles	> 5 million at minimum scanning intensity

**Mechanical Dimensions**



Abb. 4-8: Mechanische Abmessungen – Tastkopf TK94A



4.8 Scanner TK9LIN50

Housing	Anodized aluminum
Protection type	IP 64
Scanning tip	Exchangeable, thread M3x6
Scanning wand length	Up to 67 mm
Scanning angle	50 mm max. stroke
Control unit connection	Small circular connector, M12x1, 8 pin
Ambient temperature	0 °C to +80 °C
Storage temperature	-25 °C to +85 °C
Scanning cycles	> 5 million at minimum scanning intensity

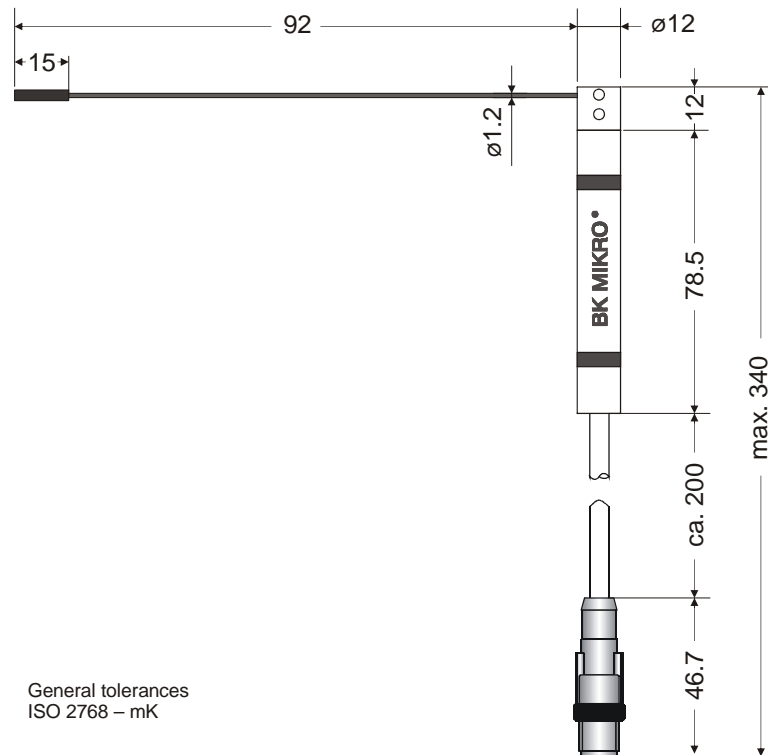
Mechanical Dimensions

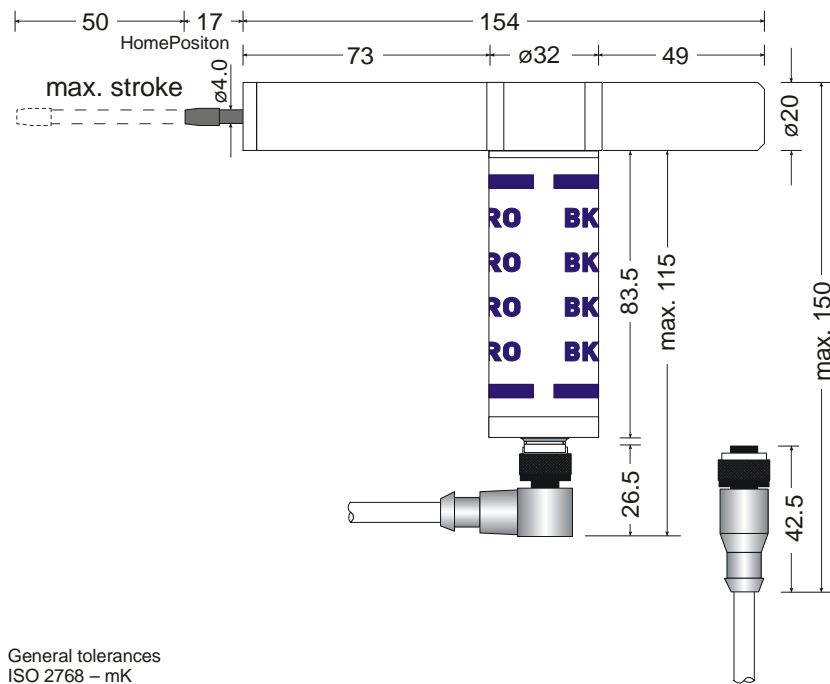

General tolerances  
ISO 2768 – mK

Fig. 4-9: Mechanical Dimensions – Scanner TK9LIN50

Option: compressed air connection

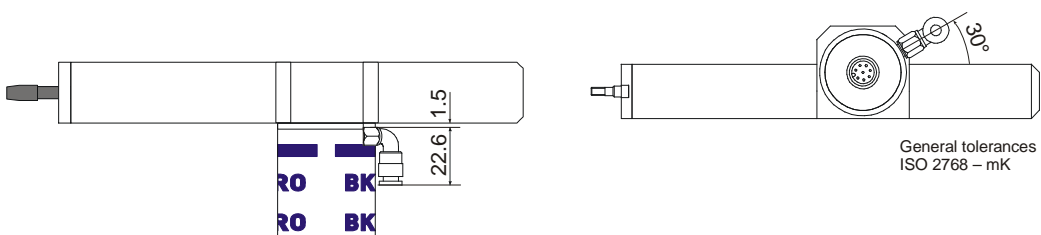

General tolerances  
ISO 2768 – mK

Fig. 4-10: Mechanical Dimensions – Option compressed air connection

**4.9 Scanner TK9LIN100**

Housing	Anodized aluminum
Protection type	IP 64
Scanning tip	Exchangeable, thread M3x6
Scanning wand length	Up to 67 mm
Scanning angle	100 mm max. stroke
Control unit connection	Small circular connector, M12x1, 8 pin
Ambient temperature	0 °C to +80 °C
Storage temperature	-25 °C to +85 °C
Scanning cycles	> 5 million at minimum scanning intensity

**Mechanical Dimensions**

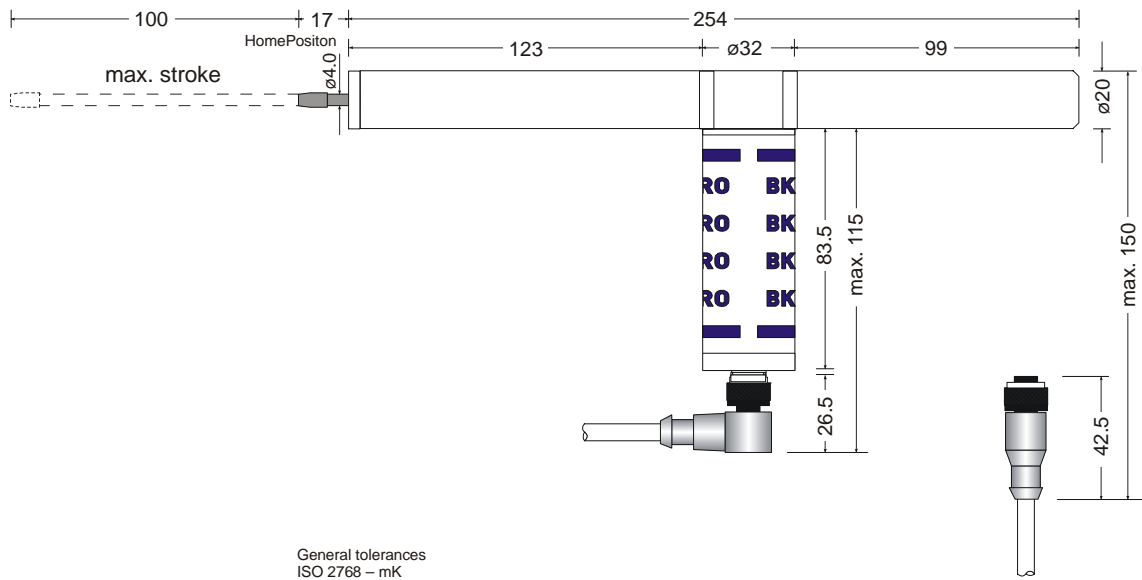

Fig. 4-11: Mechanical Dimensions – Scanner TK9LIN100

**Option: Compressed air connection**

Example:  
TK9LIN50

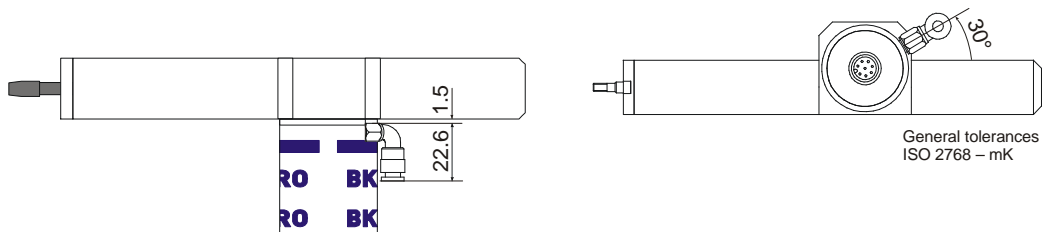

Fig. 4-12: Mechanical Dimensions – Option compressed air connection

## 4.10 Accessories

### 4.10.1 Scanning wand set

Scanner TK9LIN50/100

Scanning tip extension,  
M3

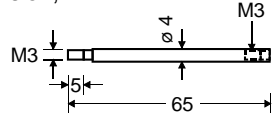

Scanner tip, brass

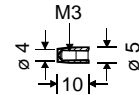

Adapter (with point of fracture  
in case of damage),  
M3

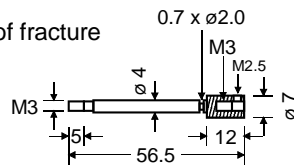

Scanner tip, plastic

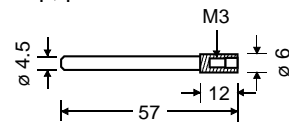

Wand holder

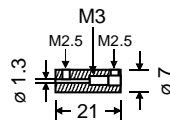

Fig. 4-13: Scanner – Accessories

## 5 Installation Notes

### 5.1 Interference prevention

All inputs are opto-decoupled which provides maximum protection against interference voltage peaks that could occur from inductive sources.

Relay outputs are protected against inductive interference voltage peaks by using varistors. Further interference suppression measures may be necessary depending on the type of load used.

If suppression measures are necessary to reduce interference these measures should be placed directly at the source of the interference.



#### **Possible additional noise filters:**

- RC combination (included in the contactor suppliers' product ranges)
- Varistors
- Diodes

## 6 Ordering Information

Control Unit	Article No.
BK MIKRO91 Premium with PB	63 04 242
BK MIKRO92 Premium without PB	63 04 243
BK MIKRO93 Basic	63 04 244
BK MIKRO9I/O Expansion Module	63 04 247

Scanner	Article No.
TK7A, with scanning wand	63 04 234
TK7RL, with scanning wand	63 04 235
TK8A, without scanning wand	63 04 237
TK91A, without scanning wand	63 04 245
TK94A, without scanning wand	63 04 249
TK94RL, without scanning wand	63 04 252
TK96A, without scanning wand	63 04 253
TK96RL, without scanning wand	63 04 254
TK9LIN50	63 04 250
TK9LIN100	63 04 251

Connection	Length	Article No.
BK MIKRO9 : Control Unit – Scanner		
Control cable, straight connector, 8 pin	5 m	62 04 251
Control cable, angled connector, 8 pin	5 m	62 04 252
Control cable, straight connector, 8 pin	15 m	62 04 253
Control cable, angled connector, 8 pin	15 m	62 04 286

Accessories and spare parts	Article No.
Scanning wands TK7A / TK7RL / TK94A / TK96RL / TK96A / TK94RL:	
– thickness 1.2 mm, length 165 mm	62 04 022
– thickness 1.2 mm, length 250 mm	62 04 216
Scanning wands TK8A:	
– thickness 3 mm, length 380 mm, plate 80x15	
Scanning wands TK91A:	
– thickness 4 mm, length 380 mm, plate 30x15	62 04 284
– thickness 4 mm, length 510 mm, plate 120x15	62 04 279
– thickness 4 mm, length 610 mm, plate 120x15	62 04 285
Scanning wands TK9LIN50/100:	
– Scanning wand set: Adapter (with point of fracture in case of damage) M3, scanning tip extension M3, scanning tip brass, scanning tip plastic M3	62 04 904
Balance weight set (2x Ø 20 mm, 1x Ø 16 mm)	62 04 282
Mounting bracket - scanning wands Ø 32 mm	61 07 082
Mounting bracket - scanning wands Ø 20 mm	61 07 165
Mounting bracket - scanning wands Ø 12 mm	61 04 302
Accessories for mounting bracket - Ø 12 mm (knuckle joint + holding arm)	61 04 303
BKM air barrier adapter	62 04 029

Operating Instructions	Article No.
BK MIKRO9	68 36 262

Basic system
63 04 242 + 62 04 279 + 62 04 251 + 63 04 245

